

VELLEDO
— 为乐电气 —

VELLEDO连接器

技术选型及产品应用简报

2022

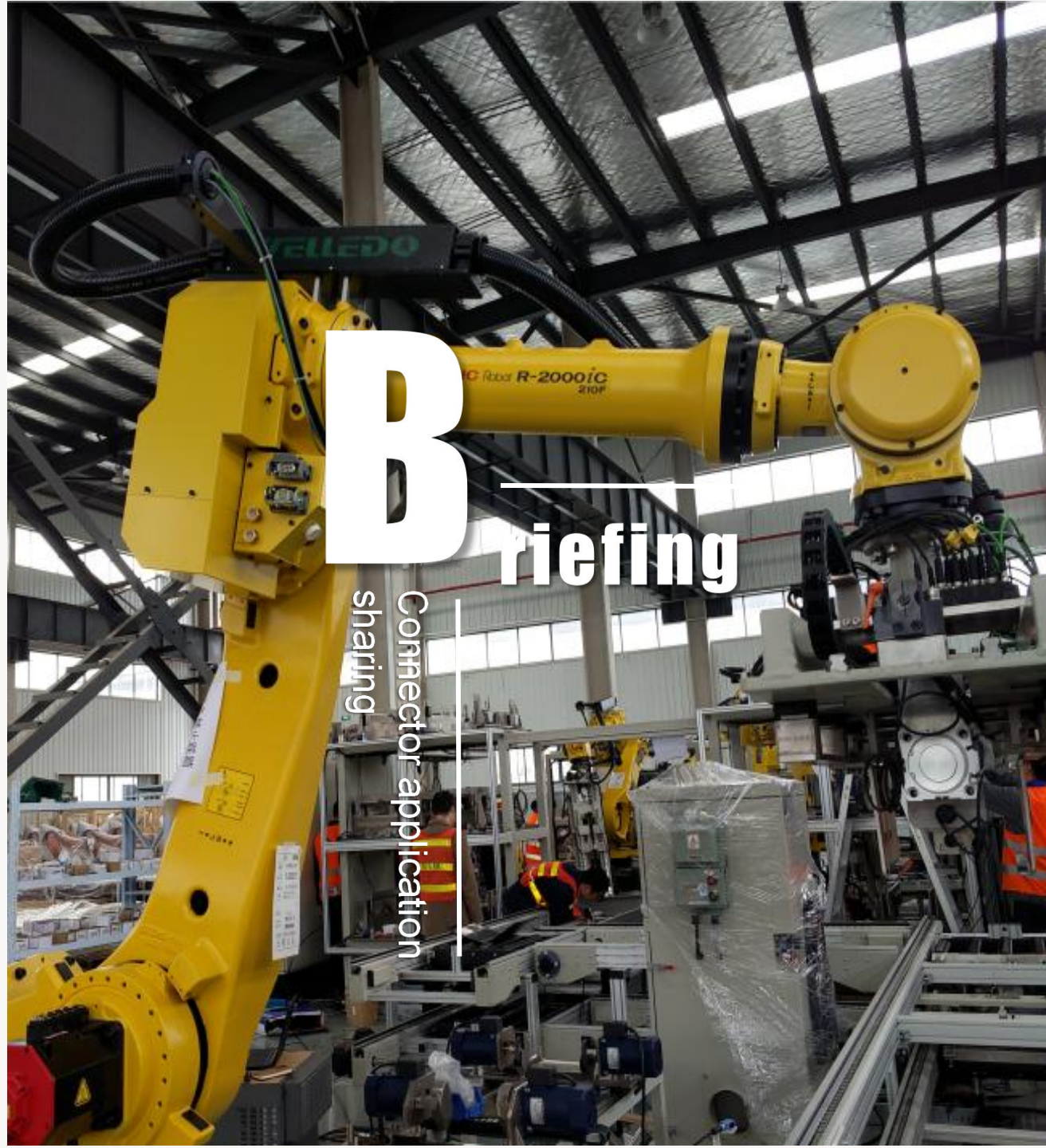

目录

CONTENTS



关于企业
About
Enterprise



产品应用
Product
Description



产品选型
Product
Selection

简报分享目标 Briefing sharing objectives :

通过本简报的分享，您将能够：

- 熟悉VELLEDQ连接器在集成项目中的应用及使用；
- 更加快速有效地开展集成项目电气设计；
- 合理规避因连接器选型影响项目成本和交期。

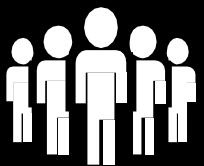

关于我们 ▶

About Us

为乐电气生产基地

VELLEDO
— 为乐电气 —



一、企业介绍

COMPANY PROFILE



为乐电气（上海）有限公司成立于2012年3月20日，系专业从事工业自动化连接系统及解决方案的研发、设计、生产、安装施工及销售业务。VELLEDQ系上海市“高新技术企业”和“专精特新”企业。VELLEDQ运营和生产本部位于上海，并在福建建设了全资的生产基地，设置：研发中心、电缆生产车间、塑料成型车间、机加工中心、装配车间、仓储物流中心等领域。

VELLEDQ拥有独立的研发、生产、物流和对外安装施工团队，主要产品有：机器人管线包、圆型接插件、分线盒、重载连接器、I/O总线模块、半导体行业线束、控制柜集成等产品。

VELLEDQ经过CE、ROSH、TUV、ISO9001:2015 质量体系认证。

VELLEDQ为乐电气产品广泛应用于工装自动化、新能源行业、半导体集成、汽车行业、3C行业、轨道交通、港口机械、物流行业、工程机械、灯具、电梯、电机马达、中央空调、口罩机流水线及非标定制等各行各业。





二、企业环境

Enterprise Environment



VELLE Electric (ShangHai) Co., Ltd.



VELLEDQ上海本部



VELLEDQ福建生产基地



二、企业环境

Enterprise Environment



VELLE Electric (ShangHai) Co., Ltd.



VELLEDQ来宾接待区

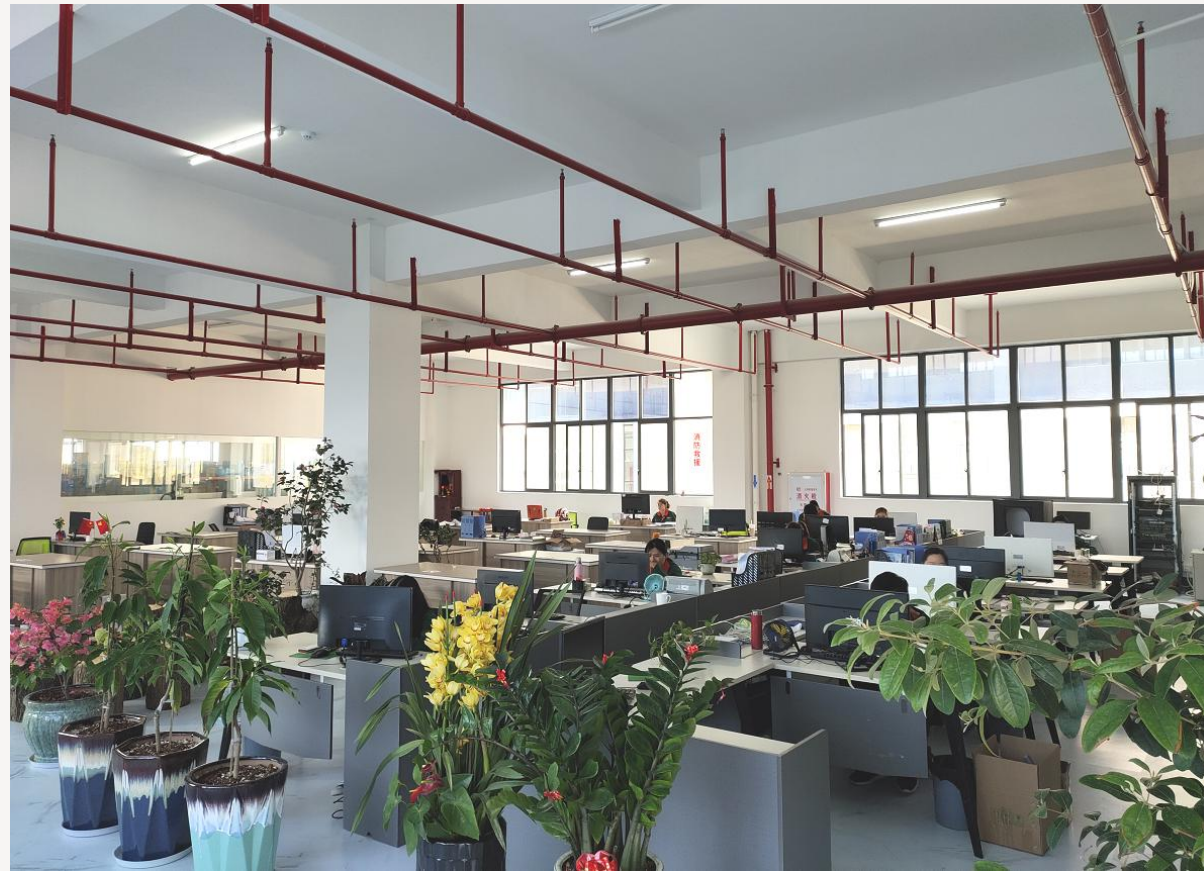

VELLEDQ办公区域



二、企业环境

Enterprise Environment

VELLEDQ
— 为乐电气 —

VELLE Electric (ShangHai) Co., Ltd.



VELLEDQ生产流水线



VELLEDQ生产车间一角



二、企业环境

Enterprise Environment

VELLEDQ
— 为乐电气 —

VELLE Electric (ShangHai) Co., Ltd.



VELLEDQ品质检测区



VELLEDQ品质检验区



二、企业环境

Enterprise Environment

VELLEDO
— 为乐电气 —

VELLE Electric (ShangHai) Co., Ltd.

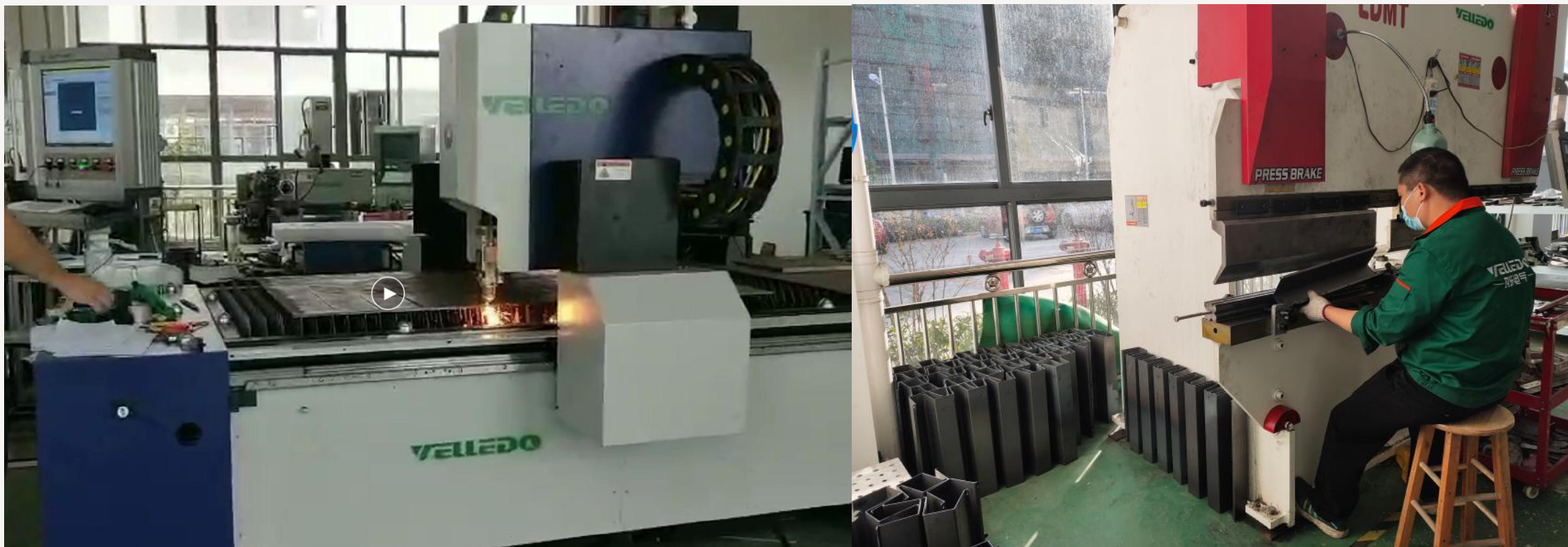

VELLEDQ机加工中心，激光切割机、折弯机等



二、企业环境

Enterprise Environment

VELLEDQ
— 为乐电气 —

VELLE Electric (ShangHai) Co., Ltd.



VELLEDQ自动化成缆流水线生产区域



二、企业环境

Enterprise Environment

VELLEDQ
— 为乐电气 —

VELLE Electric (ShangHai) Co., Ltd.



VELLEDQ自动化数控设备、自动化塑料成型、自动化非标生产设备的运用，有效提升了生产效率和产品品质。



二、企业环境

Enterprise Environment

VELLEDQ
— 为乐电气 —

VELLE Electric (ShangHai) Co., Ltd.

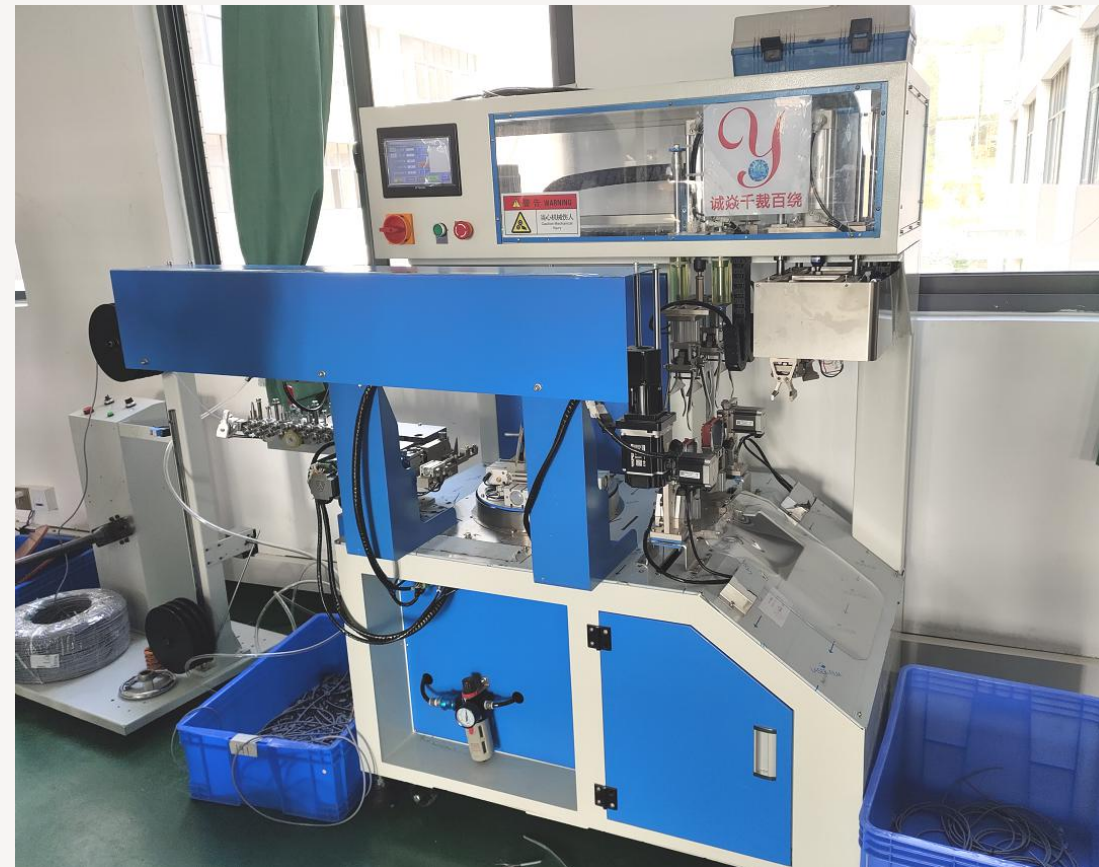

VELLEDQ自动化塑料成型车间



二、企业环境

Enterprise Environment



VELLE Electric (ShangHai) Co., Ltd.



精密盐雾试验机



恒温恒湿试验机



二次元分析仪



二、企业环境

Enterprise Environment

VELLEDQ
— 为乐电气 —

线材导通测试仪

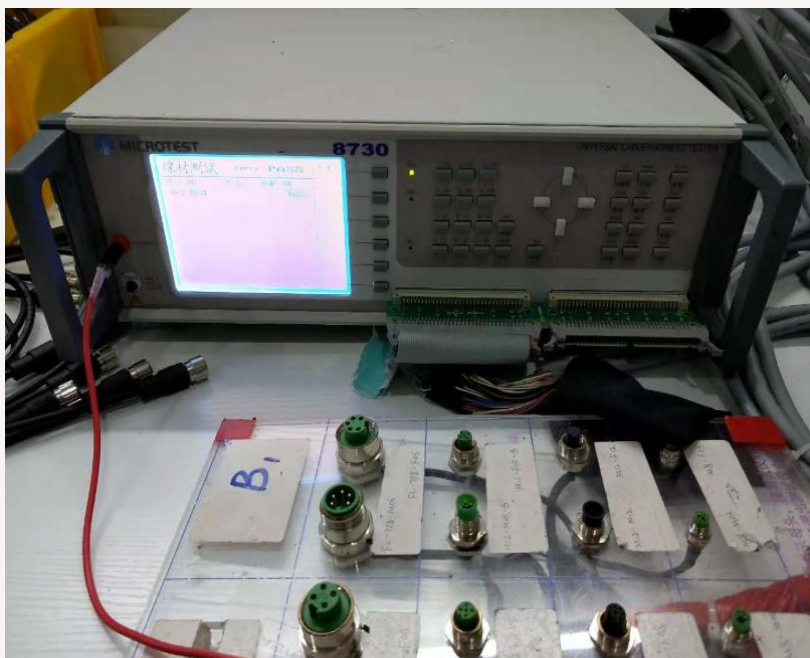

原装进口电镀层测厚



VELLEDQ检测试验设备



三、企业资质

Qualification certification



VELLE Electric (ShangHai) Co., Ltd.

营业执照
(副本)

统一社会信用代码 91310117591694373T
证照编号 27000000201710270389

名称 为乐电气(上海)有限公司
类型 有限责任公司(自然人投资或控股)
住所 上海市松江区松冈路258号第1幢4层401室
法定代表人 林燕燕
注册资本 人民币1000.0000万元整
成立日期 2012年3月20日
营业期限 2012年3月20日至2032年3月19日
经营范围 工业连接器的研发、设计、生产、加工、安装及销售; 电力设备、电子产品、电线电缆、机电设备及配件、机械设备及配件、通信设备、仪器仪表、管道配件、汽车配件、船舶设备及配件、五金交电的销售; 从事货物与技术的进出口业务。
【依法须经批准的项目, 经相关部门批准后方可开展经营活动】

登记机关
提示: 每年1月1日至6月30日
登录企业信用信息公示系统报
送并公示上年度企业年报信息

2017年10月27日

企业信用信息公示系统网址: <https://www.gs.gov.cn/notice> 中华人民共和国国家工商行政管理总局监制

管理体系认证证书

认证编号: 117 20 QU 0294-04 R15

兹证明 **为乐电气(上海)有限公司**
统一社会信用代码 91310117591694373T

地址 **上海市松江区松冈路258号第1幢4层401室**

经现场评审满足: GB/T19001-2016/ISO9001:2015 质量管理体系要求

认证范围 **线束组件、机器人管线包的生产; 重载连接器的生产(外协) 和销售**

初次发证: 2017年05月09日
复评发证: 2020年04月28日
有效期至: 2023年05月08日

上海英格尔认证有限公司
国家认监委批准号: CNCA R-2003-117
电话: 400-152-9001/+86 21-51114700
网址: www.icas.org.cn
地址: 上海市徐汇区中山西路2368号
华鼎大厦801室 200235

认证证书

证书号: 11421Q42168R0M

兹证明
为乐电气(福建)有限公司
统一社会信用代码: 91350622MA33R52T63

注册地址: 福建省漳州市云霄县云陵工业开发区云翔产业园
生产办公地址: 福建省漳州市云霄县云陵工业开发区益树大道1号移民创业园1栋东侧1-3楼

质量管理体系符合标准
GB/T19001-2016/ISO9001:2015
质量管理体系适用范围
线束组件、重载连接器、机器人管线包的生产

初次发证日期: 2021年04月12日
证书颁发日期: 2021年04月12日
证书有效期至: 2024年04月11日

签发: 吴凤苗

北京东方纵横认证中心有限公司

EACC IAF CNAS

VELLEDQ上海本部工厂和福建生产基地通过GB/T19001-2016/ISO9001:2015管理体系认证



三、企业资质

Qualification certification



VELLE Electric (ShangHai) Co., Ltd.



VELLEDQ为乐电气系上海市“高新技术企业”，也是上海市“专精特新”中小企业。



三、企业资质

Qualification certification



VELLE Electric (ShangHai) Co., Ltd.

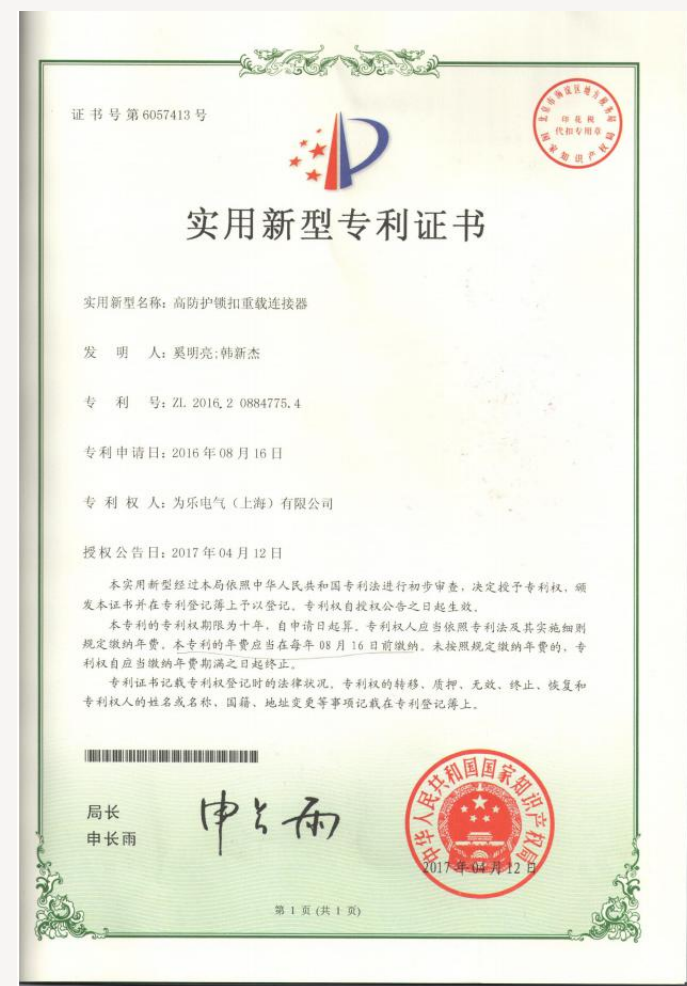
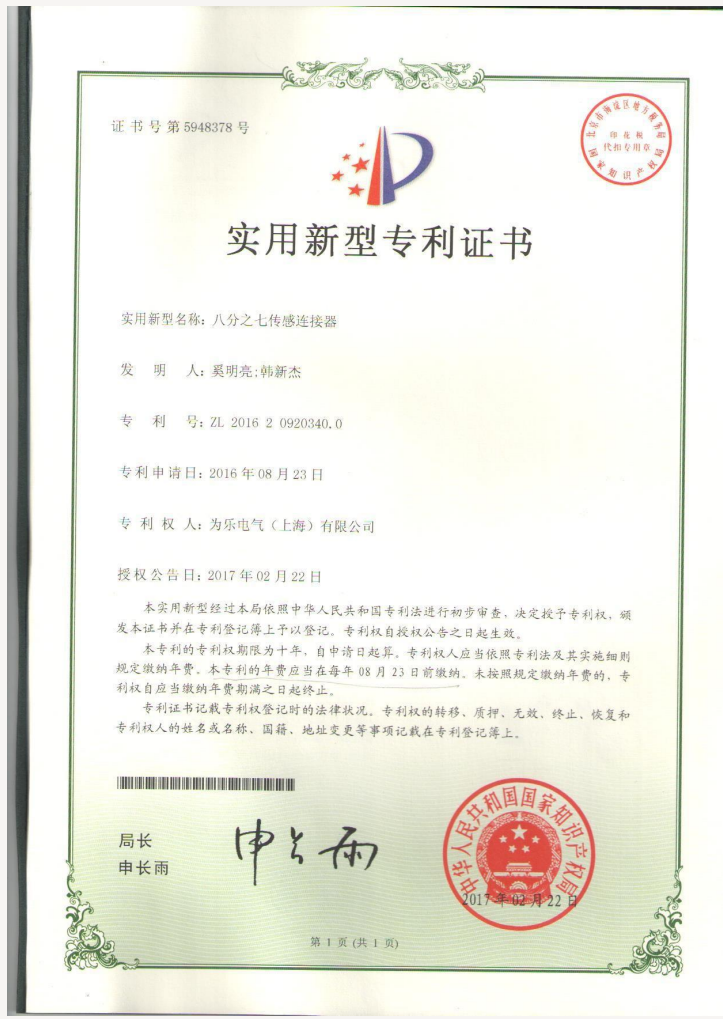
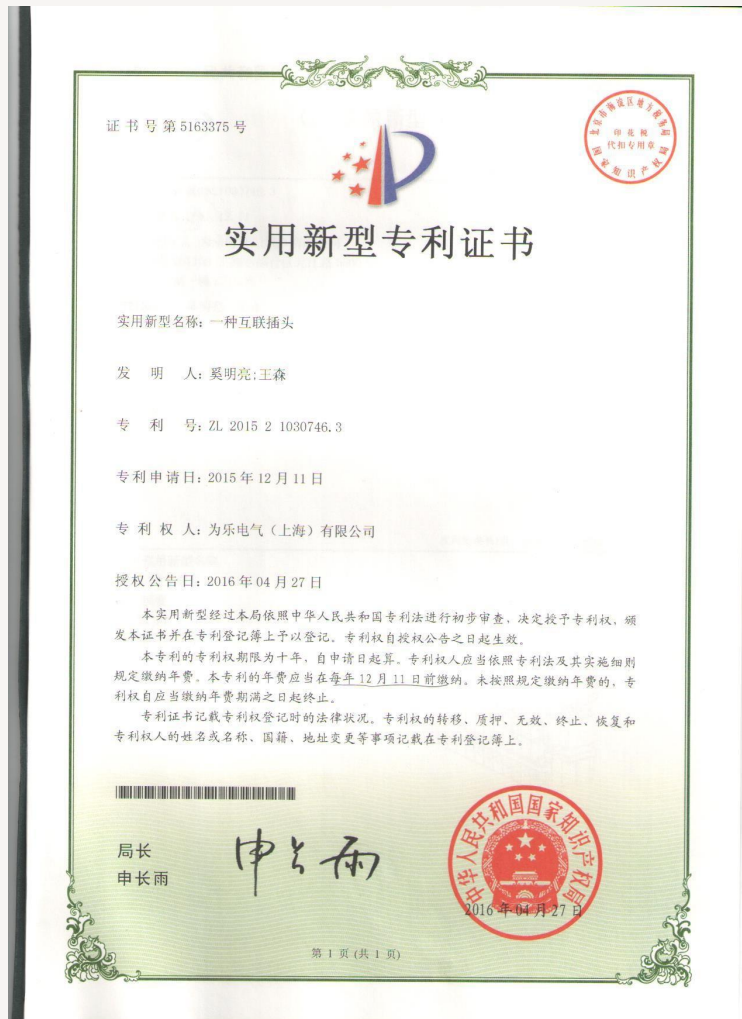

VELLEDQ已取得数十项的发明专利、实用新新专利、外观设计专利和软件著作权专利。



三、企业资质

Qualification certification



VELLE Electric (ShangHai) Co., Ltd.

BST A RELIABLE TESTING FOR TRUST
MEASUREMENT AND CERTIFICATION OF ELECTRICAL AND ELECTRONIC EQUIPMENT

Certificate of Compliance

Certificate No : BST1707764030002Y-1EC-1
 Applicant : VELLE ELECTRIC(SHANGHAI) CO., LTD
 No.500 Shuhai Road, Songjiang District, Shanghai, China.
 Manufacturer : VELLE ELECTRIC(SHANGHAI) CO., LTD
 No.500 Shuhai Road, Songjiang District, Shanghai, China.
 Product Name : DISTRIBUTION SYSTEMS
 Trade Name :

Main Test Model : WL4K-M12-K4-PNP
 Additional Model : See Annex
 Test Standard : EN 55032:2015
 EN 61000-3-2:2014
 EN 61000-3-3:2013
 EN 55024:2010/A1:2015

As shown in the Test Report No. : BST1707764030002Y-1ER-1.

The EUT described above has been tested by us with the listed standards and found in compliance with the council EMC directive 2014/30/EU. It is possible to use CE marking to demonstrate the compliance with this EMC Directive.
 The certificate applies to the tested sample above mentioned only and shall not imply an assessment of the whole production.

Shenzhen BST Technology Co.,Ltd.
 Add: Building No.23-24, Ziheng Industrial Park, Guanikouer Road, Nantou,Nanshan District,Shenzhen,Guangdong China
 Certificate Search: <http://www.bst-lab.com> Tel:400-882-9628, 8009990305, E-mail:christina@bst-lab.com

CTC Shenzhen Circle Testing Certification Co., Ltd.
 Add: East,1 Floor,Building 1, Donglongxing Technology Park, Huanging Road,Longhua District, Shenzhen,China
 Tel: 400-188-1878
 E-mail: service@c-cert.com
 Certificate Search: www.c-cert.com

DECLARATION OF CONFORMITY

Certificate No. : CTC20042291RC
 Applicant : VELLE ELECTRICAL(SHANGHAI) CO., LTD.
 Address : No.1 Building, No.500 Shuhai Road of Songjiang Economic & Technological Development Zone, ShangHai, China
 Manufacturer : VELLE ELECTRICAL(SHANGHAI) CO., LTD.
 Address : No.1 Building, No.500 Shuhai Road of Songjiang Economic & Technological Development Zone, ShangHai, China
 Product Name : I/O CONNECTOR
 Main Test Model : M12-M04T
 Additional Model : M12-M05T,M12-M08T,M12-F04T,M12-F05T,M12-F08T,M12-M04S,M12-M05S,M12-M08S,M12-F04S,M12-F05S,M12-F08S,M8-M03T,M8-F03T,M8-M03S,M8-F03S,M8-M04T,M8-F04T,M8-M04S,M8-F04S

Test Standard : EN 62321:2009 EN 62321-1:2013
 EN 62321-2:2014 EN 62321-4:2014
 EN 62321-5:2014 EN 62321-6:2015
 EN 62321-7-1:2015 EN 62321-8:2017

Report No. : CTC20042291RR

The EUT described above has been tested by us and found in compliance with the council Directive 2015/863/EU(RoHS 2.0) at last amended by Directive(EU) 2017/2102. It is only valid in connection with the test.

Date of Issue: May 07, 2020

Davis Wei
 Manager

Zertifikat Certificate

Zertifikat Nr. Certificate No. Blatt Sheet
 R 50469402 0001

Ihr Zeichen Client Reference Unser Zeichen Our Reference Ausstellungsdatum Date of Issue
 H.X.J. 01-ZMJ-50350751 001 01.06.2020 (day/month/year)

Genehmigungsinhaber License Holder Fertigungsstätte Manufacturing Plant
 VELLE Electrical(ShangHai) Co., Ltd Xiamen VELLE Electrical Co., Ltd.
 No.1 Building, No.500 Shuhai Road 5 / F, 181 Siming garden, Tong'an
 of Songjiang Economic & Technologic Industrial Zone, Xiamen,
 Development Zone Fujian
 Shanghai P.R. China

Prüfzeichen Test Mark Geprüft nach Tested acc. to
 EN 61984:2009

Zertifiziertes Produkt (Geräteidentifikation) Lizenzentgelte - Einheit
 Certified Product (Product Identification) License Fee - Unit

Connector (Connector)

Type Designation : HK-u-P HM-v-P 5
 HA-y-P HQ-t-P HSB-x-F
 HB&HEE-z-F HD&HDD-w-F
 HK-u-M HM-v-M
 HB-y-M HQ-t-M HSB-x-M
 HB&HEE-z-M HD&HDD-w-M
 x, y, z, t, u, v, w are variable

Rated Voltage : AC/DC 250V
 Rated Current : Max.10A
 Temperature Limits : -40°C to +125°C
 Ambient Temperature : -40°C to +85°C
 Overvoltage Category : III
 Pollution Degree : 3
 Degree of Protection : IP65 (after mounted and engaged)

ANLAGE (Appendix): 1.0

Dem Zertifikat liegt unsere Prüf- und Zertifizierungsordnung zugrunde und es bestätigt die Konformität des Produktes mit den oben genannten Standards und Prüfgrundlagen. Zusätzliche Anforderungen in Ländern, in denen das Produkt in Verkehr gebracht werden soll, müssen zusätzlich betrachtet werden. Die Herstellung des zertifizierten Produktes wird überwacht.
 This certificate is based on our Testing and Certification Regulation and states the conformity of the product with the standards and testing requirements as indicated above. Any additional requirements in countries where the product is going to be marketed have to be considered additionally. The manufacturing of the certified product is subject to surveillance.

TÜV Rheinland LGA Products GmbH, Thylistraße 2, 90431 Nürnberg
 Tel.: +49 221 806-1371 e-mail: cert-validity@de.tuv.com
 Fax: +49 221 806-9535 <http://www.tuv.com/safety>

VELLEDQ产品已通过CE认证、ROHS认证、TUV认证、IP67等产品测试和认证。



四、企业优势

Our advantage

VELLEDQ
— 为乐电气 —

1

诚信为本

2

质量优先

3

精准供应

4

持续改善

VELLEDQ技研工程师和销售工程师都经过专业的培训，并不断加大在技术和人员引进等方面的投入。VELLEDQ凭着优异的产品品质，为广大中外企业用户提供更高效的服务。

VELLEDQ坚持以用户需求为导向，持续性改进产品品质和服务，精准地为用户提供高性价比的电气连接与保护产品。



应用领域 ▶
Application area





工装

为乐产品提供从工装夹具端到控制柜端，包括电、气、信号、协议通讯等连接及保护方案

控制柜



VELLEDQ 机器人管线包解决方案，涵盖自行生产线束线缆和接插件的应用，国内仅有。



STEP-1



STEP-2



STEP-3



STEP-4



STEP-5

I/O元器件配套物料:

- 1、现场安装插头，M8/M12
- 2、I/O线缆用于传感器线延长
- 3、单端或双端预铸延长线束
- 4、以太网通讯线束

I/O信号连接方式:

- 1、分线盒 (集线器)
- 2、I/O总线模块
- 3、重载连接器
- 4、端子台

有线连接物料需求:

- 1、分线盒延长线
- 2、总线模块电源线和协议线
- 3、重载连接器多芯线
- 4、端子台连接多芯线

控制柜外侧快插快拨连接方式:

- 1、重载连接器连接多芯线
- 2、圆型M8/M12/7/8法兰
- 3、穿墙板应用
- 4、D-SUB底座及预铸线应用

控制柜内侧连接需求:

- 1、单芯线
- 2、协议通讯接头及线缆
- 3、以太网协议通讯预铸线束
- 4、重载连接器





一、光伏半导体行业

Photovoltaic semiconductor industry

VELLEDQ
— 为乐电气 —

VELLE Electric (ShangHai) Co., Ltd.



跟随中国的半导体行业近年一直保持着顽强的发展态势，经历了国外技术的封锁，中国半导体行业不仅挺过来了，而且迎来了发展黄金期。VELLEDQ为乐电气以工业连接器和线束生产能力为依托，紧密配合国内外光伏半导体企业，为其提供半导体设备线束集成、控制柜成套加工等产品。

主要的服务的客户有：美国应用材料集团、理想晶延、中国汉能等光伏半导体企业。





二、新能源行业

New energy industry

VELLEDQ
— 为乐电气 —

VELLE Electric (ShangHai) Co., Ltd.



因应国家新能源发展战略的 导向，新能源汽车电池、电驱 动行业快速发展。新能源PACK 模组自动化生产流水线需求日益旺盛。VELLEDQ为乐电气积极响应，并为新能源行业自动化 产线提供机器人管线包、M8、M12、7/8、RJ45、分线盒、重 载连接器、D-SUB、穿墙板等现 场接插件和定制线束。

主要项目有：宁德时代、比亚迪、上汽时代、镇江北汽新能源、吉利新能源、一汽新能源、国轩高科、中航锂电、亿纬锂能、蜂巢等项目。





三、工程机械行业

Construction machinery industry

VELLEDQ
— 为乐电气 —

VELLE Electric (ShangHai) Co., Ltd.



中国国力日益强大，响应国家新基建、大力发展基础设施建设和港口自动化设施设备。

VELLEDQ为乐电气为重型工程机械、塔吊、泵送、起重、履带、重卡、路基、环卫、混凝土搅拌，行车及相关自动化控制设施设备提供重载连接器、阀插头、M12分线盒、M12预铸线束、CAN通讯线束、RJ45以太网通讯线束等现场接插件和定制线束。主要服务厂商和项目有：徐工、三一重工、德仕达、青岛九和、上海科尼、河南卫华、纽科纶、慧盟重工、振华港机等。



四、汽车行业

Automobile industry

VELLEDQ
— 为乐电气 —

VELLE Electric (ShangHai) Co., Ltd.



汽车行业作为最庞大的支柱产业，VELLEDQ为乐电气为汽车主机厂和零部件厂实现自动化高效率生产大量提供机器人管线包、M8、M12、7/8、RJ45、分线盒、重载连接器、D-SUB、穿墙板等现场接插件和定制线束。主要服务厂商有：杜尔涂装、申克、北京奔驰、宝马、丰田、本田、吉利、通用汽车、大众汽车、福特汽车、长安汽车、前途、威马、小鹏、华域汽车、华菱汽车等汽车厂商。

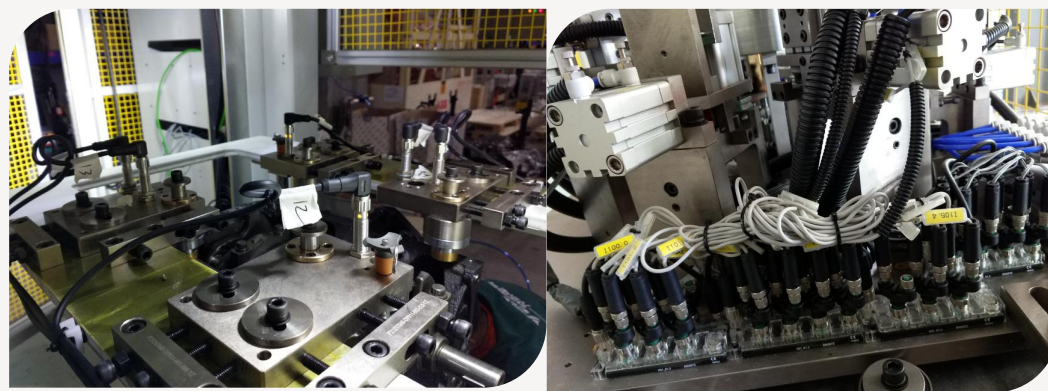



五、3C行业

3C industry

VELLEDQ
— 为乐电气 —



VELLE Electric (ShangHai) Co., Ltd.

VELLEDQ为乐电气因应当前对手机、5G建设及口罩机流水线设备的大幅需求，VELLEDQ为国内外3C产品、一次性口罩和N95口罩产品高效率生产和5G基站建设大量提供M8、M12、M16、7/8、RJ45、分线盒、重载连接器、D-SUB、穿墙板等现场接插件和定制线束。主要服务厂商有：苹果、华为、中兴、富士康、京东方等品牌厂商。



六、轨道交通行业

Rail transit industry

VELLEDQ
— 为乐电气 —



中国高铁的发展举世瞩目，近年来，VELLEDQ 为乐电气全力配合动车组 车厢、轨道闸机、轻轨电源、信号、协议通讯提供 M8、M12、7/8、RJ45、分线盒、重载连接器、D- SUB、法兰等现场接插件和定制线束。主要服务厂商和项目有：中国中车、杭州地铁等。





七、物流行业

Logistics industry

VELLEDQ
— 为乐电气 —

VELLE Electric (ShangHai) Co., Ltd.



随着中国物流行业迅速发展，物联网自动化控制技术为更高效进行物料分类、存放、装运提供了必备的设施和设备。VELLEDQ为乐电气为物流仓储、装卸设施设备、无人驾驶叉车等M8、M12、7/8、RJ45、分线盒、重载连接器、D-SUB、电磁阀、法兰等现场接插件和定制线束。

主要服务厂商和项目有：施耐德、振华港机、德马物流等。



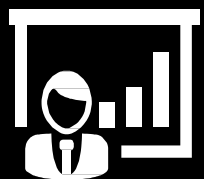

产品选型 ▶

Product Selection



主要产品系列

Main product series

VELLEDQ
— 为乐电气 —

机器人管线包
Dresspack systems

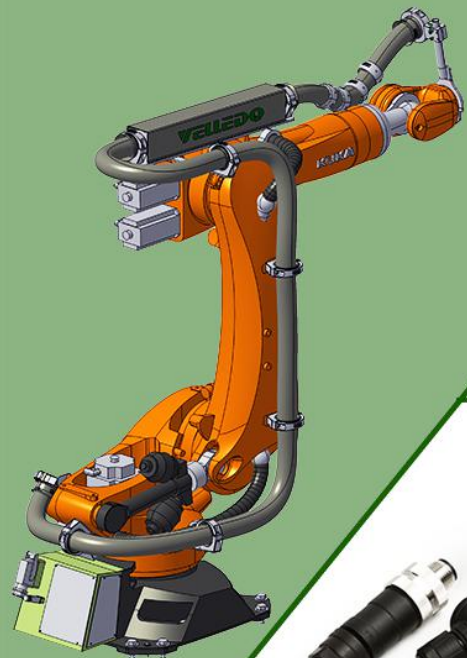

为乐重载连接器
Heavy-duty connector



预铸线束
Wire harness



I/O连接器及I/O分线盒
I/O Connector of unction Box



工业总线及交换机
Industrial bus and switch





一、机器人管线包

Robot Dresspack

VELLEDQ
— 为乐电气 —

机器人管线包 Robot Dresspack systems



机器人管线包作为VELLEDQ战略性产品，具备可提供管线包零部件、管线包线束和接插件之成套设计、生产和安装的能力，这是其他品牌机器人管线包厂家所不具备的。

针对不同品牌和不同用途的机器人运用，VELLEDQ已有较为成熟的管线包整体解决方案的选型、设计思路和现场施工调试经验。

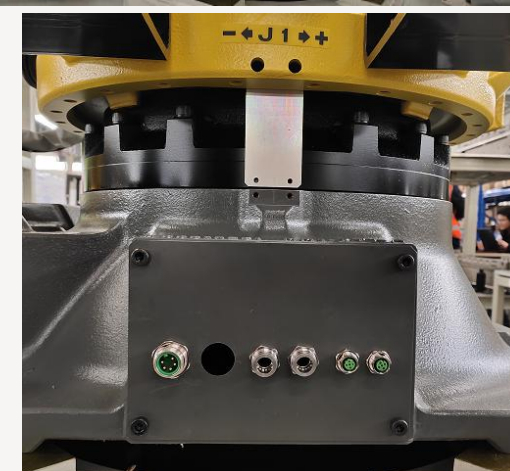



一、机器人管线包

Robot Dresspack

VELLEDO
— 为乐电气 —

VELLE Electric (ShangHai) Co., Ltd.





二、预铸线束

Wire harness

VELLEDO
— 为乐电气 —

连接线束 Wire harness

主要产品：M8、M12、7/8、M23
USB、RJ45、D-sub等系列连接器

广泛应用于工装现场：数据传输,传感器传输
电源传输总线协议

CANopen PROFINET[®] EtherCAT[®]

EtherNet/IP[™] CC-Link PROFINET[®] BUS DeviceNet

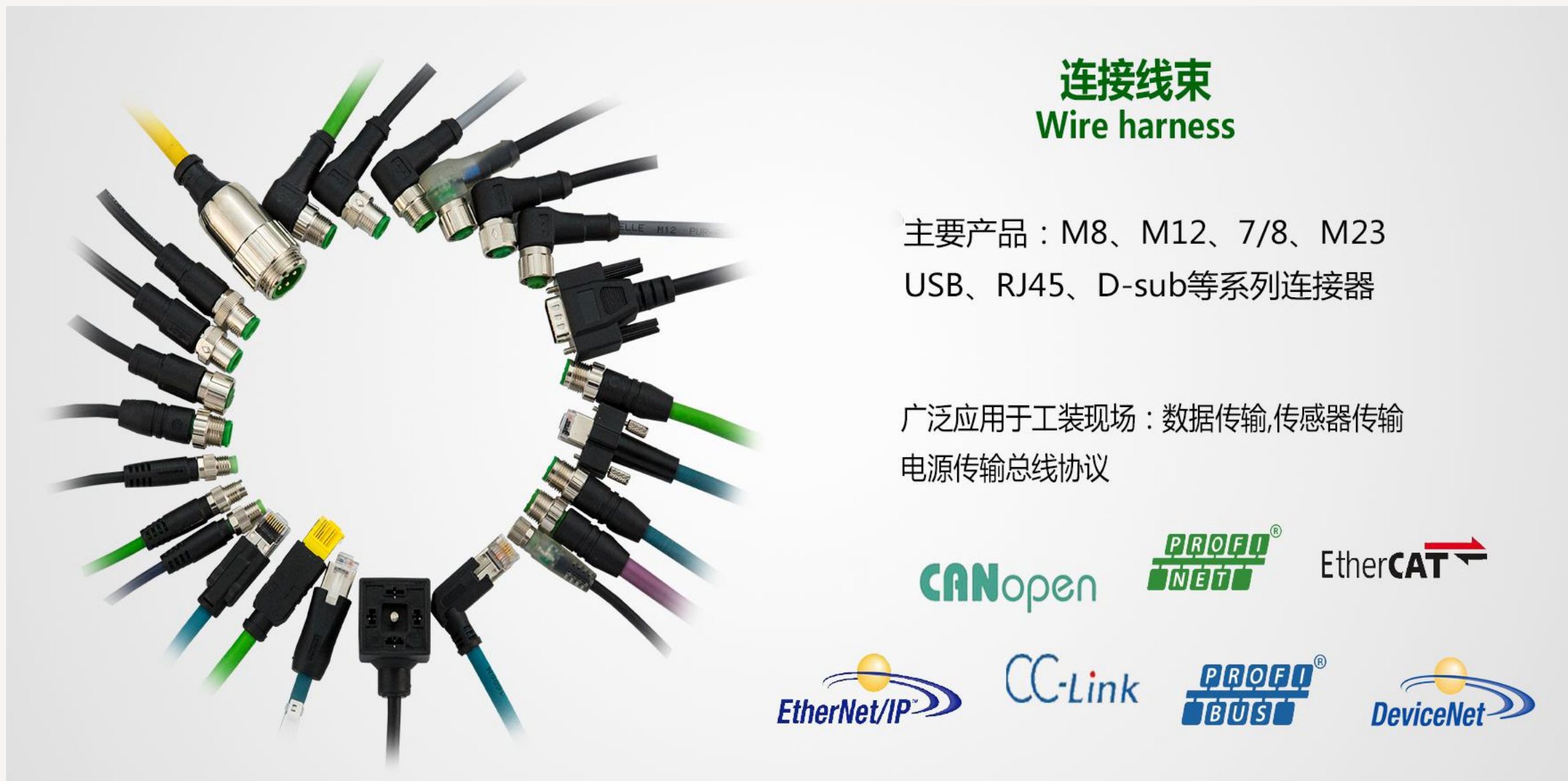



二、预铸线束

Wire harness

VELLEDO
— 为乐电气 —

VELLE Electric (ShangHai) Co., Ltd.

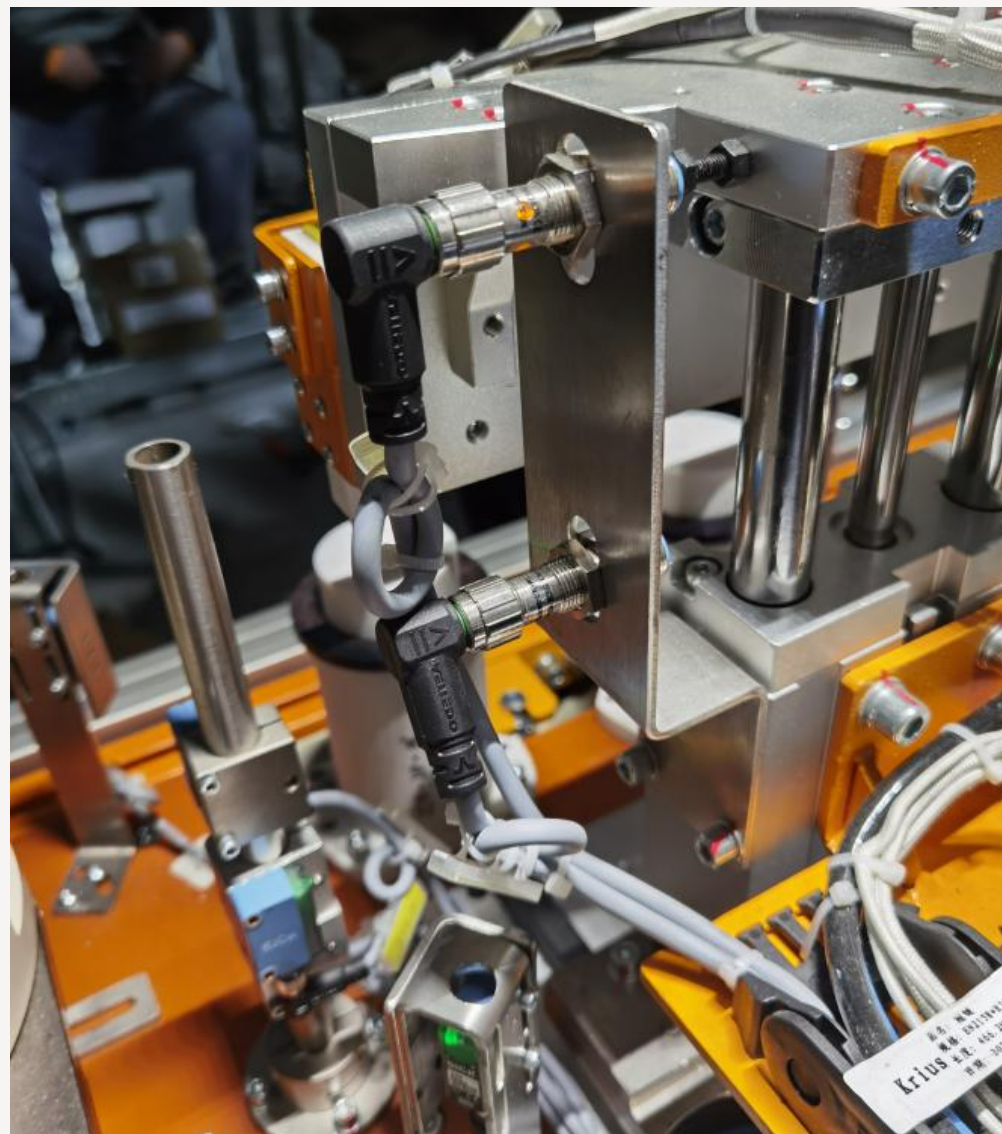
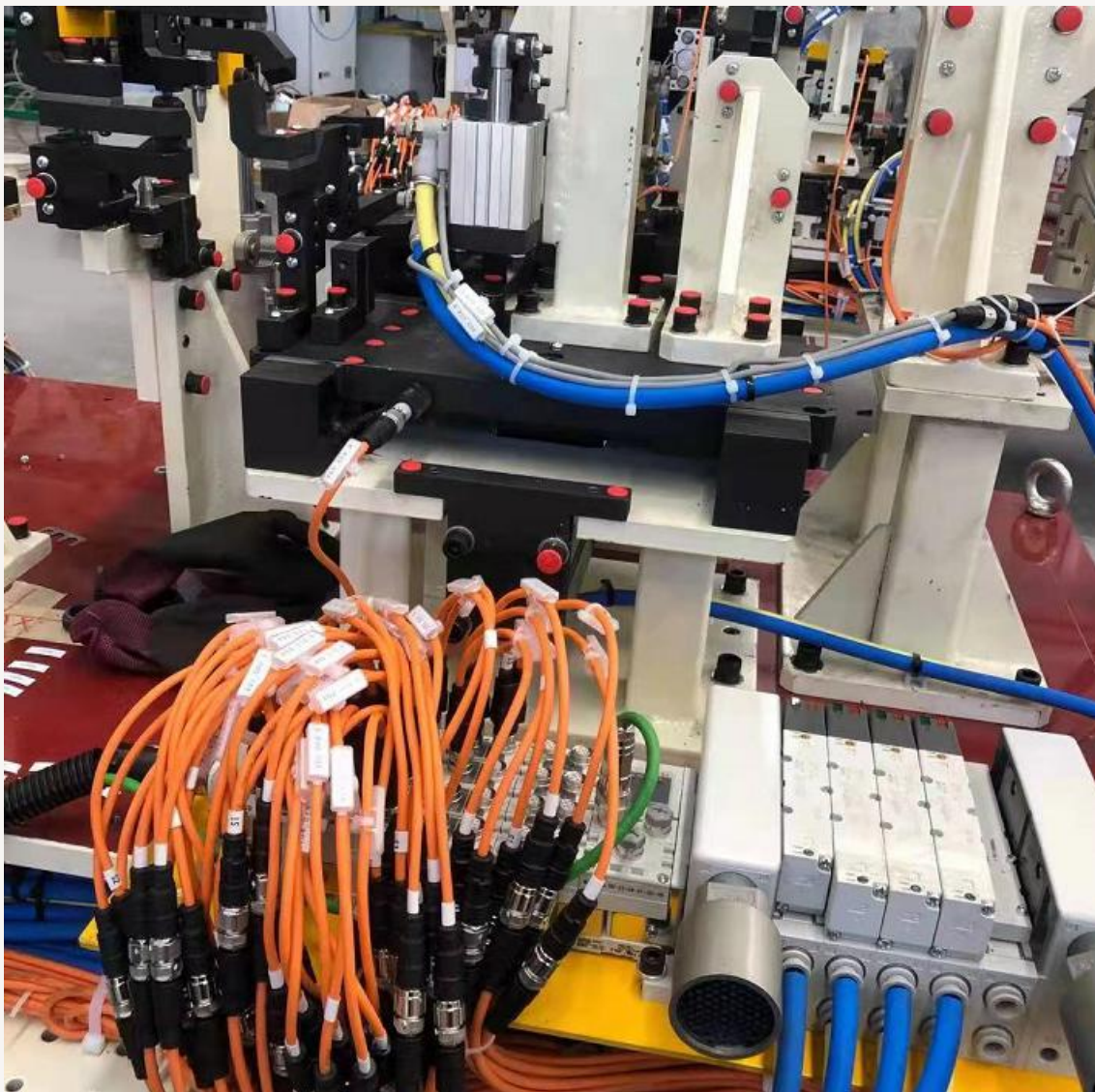



三、标准接插件

Standard connector

VELLEDO
— 为乐电气 —

I/O连接器
I/O connector



I/O连接器：M8、M12、7/8、RJ45现场安装及法兰连接器，
可实现多款柜体出线连接及现场快速连接



三、标准接插件

Standard connector



VELLE Electric (ShangHai) Co., Ltd.

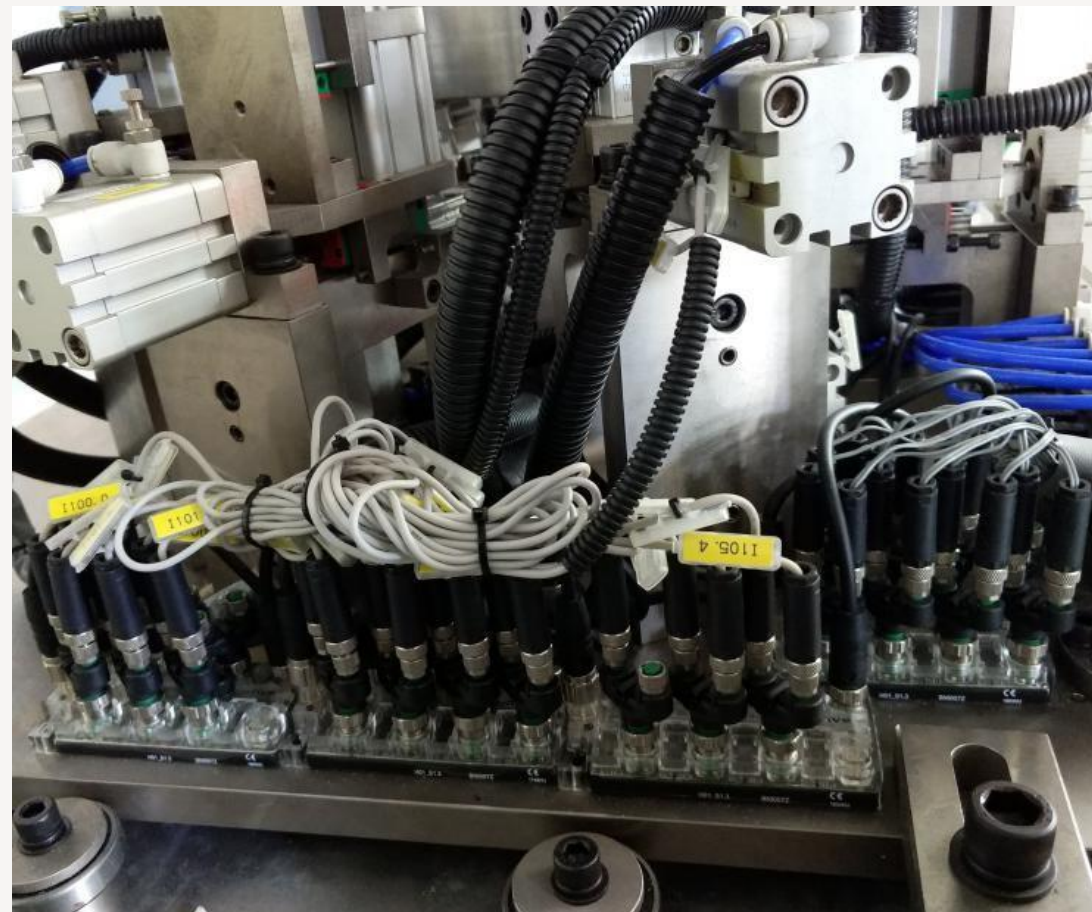



四、重载连接器

Heavy-duty connector

VELLEDO
— 为乐电气 —

重载连接器
Heavy-duty connector



重载连接器: 可完美实现气、电、信号、流体一体化连接



四、重载连接器

Heavy-duty connector

VELLEDO
— 为乐电气 —

VELLE Electric (ShangHai) Co., Ltd.





五、分线盒

Junction Box

VELLEDO
— 为乐电气 —

分线盒 Junction Box



多口I/O信号分配

让您的工装布线更加简洁、方便

M8系列:
4孔、8孔、12孔;
PNP、NPN、无元件

M12系列:
4孔、6孔、8孔、12孔;
PNP、NPN、无元件



五、分线盒

Junction Box

VELLEDQ
— 为乐电气 —

VELLE Electric (ShangHai) Co., Ltd.





六、总线模块

I/O bus module



I/O总线
I/O Bus module

适用协议：





六、总线模块

I/O bus module

VELLEDQ
— 为乐电气 —

VELLE Electric (ShangHai) Co., Ltd.





七、非标定制线束

Non standard customized harness

VELLEDQ
— 为乐电气 —



VELLEDQ为进一步提升用户快速实现接插件及线束的高效率运用，全面性开展非标定制线束的加工和装配，有效节省用户物料的采购、备料时间，更主要的是节省人力的损耗，更可有效降低各项边际成本。



七、非标定制线束

Non standard customized harness

VELLEDO
— 为乐电气 —

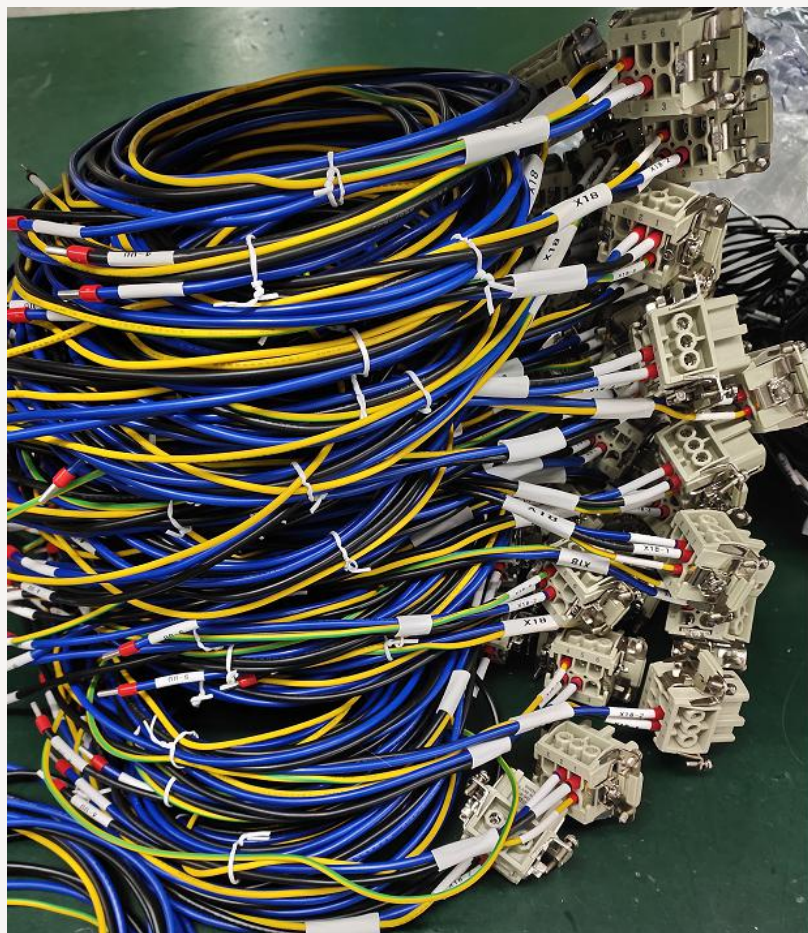



八、控制柜成套方案

Complete scheme of control cabinet

VELLEDO
— 为乐电气 —

VELLE Electric (ShangHai) Co., Ltd.





八、控制柜成套方案

Complete scheme of control cabinet

VELLEDQ
— 为乐电气 —

VELLE Electric (ShangHai) Co., Ltd.





八、控制柜成套方案

Complete scheme of control cabinet

VELLEDO
— 为乐电气 —

VELLE Electric (ShangHai) Co., Ltd.





选型基础 ▶

Selection basis



一、I/O连接器 I/O Connector & Harness



Sensor plug wire harness and flange

M8、M12、7/8等多款法兰
安装连接器及线束
可实现多款柜体出线连接



1、常规I/O线缆-分类 Cable classification

PVC

当前最经济且比较常规使用的I/O信号和电源线缆，仅能固定安装，对工况环境有要求。分屏蔽和无屏蔽两种（实物演示说明）

PUR

柔性较PVC好，抗油，适用于移动安装。分屏蔽和无屏蔽两种（实物演示说明）

TL
拖链
线

具备PUR全部优点，外被材料更为耐磨，耐折弯。适合走拖链槽或机器人管线包，分屏蔽和无屏蔽两种（实物演示说明）

防焊
渣线

具备PUR全部优点，外被材料使用高阻燃材料，主要用于焊接工装（实物演示说明），分屏蔽和无屏蔽两种（实物演示说明）



1、常规I/O线缆-运用Cable application

M8	3*0.25		3*0.25mm ² PVC	黑色	4*0.25		4*0.25mm ² PVC	黑色				
M12	3*0.34		3*0.25mm ² 防焊油	橙色	4*0.34		4*0.34mm ² 适用于拖链	灰色	5*0.34		5*0.34mm ² PUR	黑色
M12	8*0.25		8*0.25mm ² PUR	黑色	12*0.14		12*0.14mm ² PVC	黑色	17*0.14		17*0.14mm ² PUR	
7/8	4G1.5		4*1.5mm ² PVC	黄色	5G1.5		5*1.5mm ² 适用于拖链	黄色				



2、常规I/O连接器-M8系列 M8 series

M8
系列

1、现场接线：3芯、4芯；公头、母头；直头、弯头

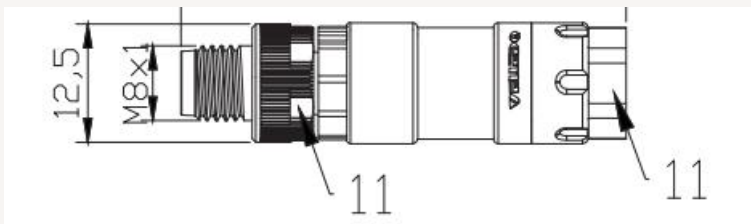

现场接线
Field-wireable
螺钉压接
Screw terminals

CE RoHS ISO 9001 (2015) 质量管理体系

接线图

型号 Form

M8-M03T M8-F03T

常备品



2、常规I/O连接器-M8系列M8 series

M8
系列

1、现场接线：3芯、4芯；公头、母头；直头、弯头--运用



M8-M03T

General Information

- Standard: IEC 61076-2-101
- Flame Retardant Rating: UL94-HB
- IP rating: IP67
- Coding: A
- Shielding: Unavailable
- Ambient Temperature: -20°C~+80°C





2、常规I/O连接器-M8系列M8 series

M8
系列

1、现场接线：3芯、4芯；公头、母头；直头、弯头--运用



2、常规I/O连接器-M8系列 M8 series

M8
系列

2、预铸线束：M8单端预铸、双端预铸3芯、4芯；公头、母头；直头、弯头

VELLE Electric (ShangHai) Co., Ltd.



双端预铸线束

Double end pre cast wire harness



ISO 9001 (2015) 质量管理体系

接线图

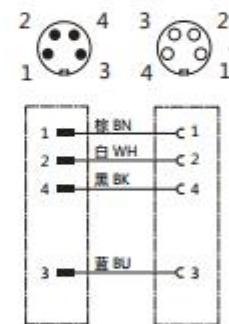
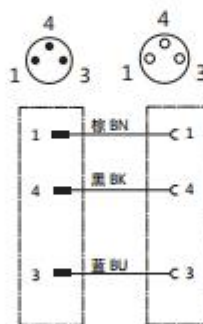
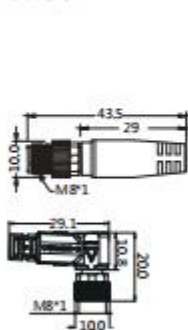

PVC	黑色3m	M8-M03T/F03S-3.0PVC/BK	M8-M04T/F04S-3.0PVC/BK
PVC	黑色5m	M8-M03T/F03S-5.0PVC/BK	M8-M04T/F04S-5.0PVC/BK
PVC	黑色10m	M8-M03T/F03S-10.0PVC/BK	M8-M04T/F04S-10.0PVC/BK
PUR	黑色3m	M8-M03T/F03S-3.0PUR/BK	M8-M04T/F04S-3.0PUR/BK
PUR	黑色5m	M8-M03T/F03S-5.0PUR/BK	M8-M04T/F04S-5.0PUR/BK
PUR	黑色10m	M8-M03T/F03S-10.0PUR/BK	M8-M04T/F04S-10.0PUR/BK
拖链	黑色3m	M8-M03T/F03S-3.0TL/BK	M8-M04T/F04S-3.0TL/BK
拖链	黑色5m	M8-M03T/F03S-5.0TL/BK	M8-M04T/F04S-5.0TL/BK
拖链	黑色10m	M8-M03T/F03S-10.0TL/BK	M8-M04T/F04S-10.0TL/BK



2、常规I/O连接器-M8系列M8 series

VELLEDO
— 为乐电气 —

M8
系列

3、法兰产品：3芯、4芯；公头、母头；前法兰和后法兰；现场焊接和预铸-运用





2、常规I/O连接器-M12系列/M12 series

M12
系列

1、现场接线：3芯、4芯、5芯、8芯、12芯；公头、母头；直头、弯头

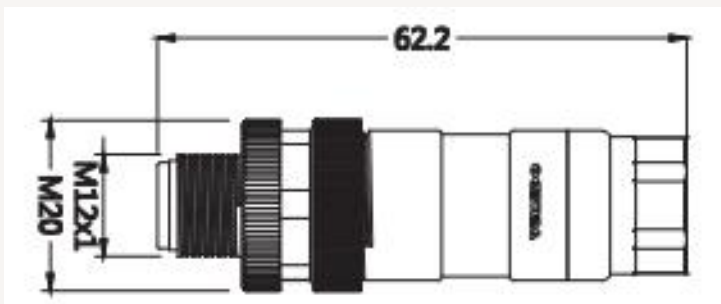

现场接线

Field-wireable

螺钉压接

Screw terminals



ISO 9001 (2015) 质量管理体系

接线图

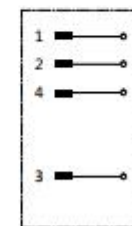
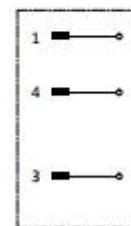

型号 Form

M12-M03T

M12-M04T

常备品



2、常规I/O连接器-M12系列/M12 series

VELLEDO
— 为乐电气 —

M12
系列

1、现场接线：3芯、4芯、5芯、8芯、12芯；公头、母头；直头、弯头





2、常规I/O连接器-M12系列/M12 series

M12 系列

1、预铸线束：M12单端预铸、双端预铸3芯、4芯、5芯、8芯、12芯、17芯；公头、母头；直头、弯头



双端预铸线束

Connection cable



ISO 9001 (2015) 质量管理体系

接线图

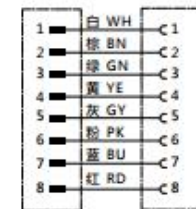
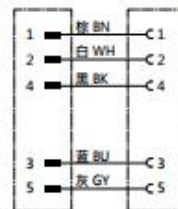
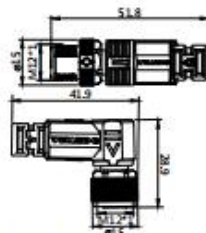
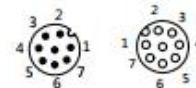
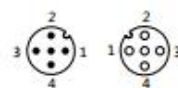

PVC	黑色3m	M12-M05T/F05S-3.0PVC	M12-M08T/F08S-3.0PVC
PVC	黑色5m	M12-M05T/F05S-5.0PVC	M12-M08T/F08S-5.0PVC
PVC	黑色10m	M12-M05T/F05S-10.0PVC	M12-M08T/F08S-10.0PVC
PUR	黑色3m	M12-M05T/F05S-3.0PUR	M12-M08T/F08S-3.0PUR
PUR	黑色5m	M12-M05T/F05S-5.0PUR	M12-M08T/F08S-5.0PUR
PUR	黑色10m	M12-M05T/F05S-10.0PUR	M12-M08T/F08S-10.0PUR



2、常规I/O连接器-M12系列/M12 series

VELLEDO
— 为乐电气 —

M12
系列

1、预铸线束：M12单端、双端预铸3芯、4芯、5芯、8芯、12芯、17芯；公头、母头；直头、弯头

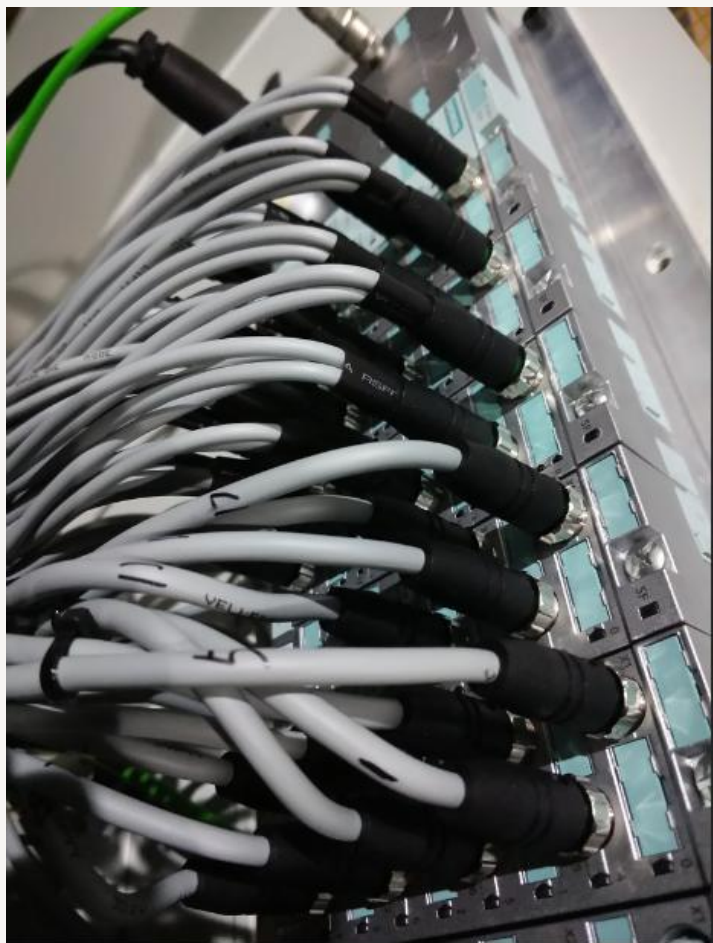



2、常规I/O连接器-M12系列/M12 series

M12
系列

3、法兰产品：3芯、4芯、5芯、8芯、12芯；公头、母头；前法兰和后法兰；现场焊线和预铸；



M12 Y型连接线束
M12 Y Connection Harness



CE RoHS ISO 9001 (2015) 质量管理体系

接线图

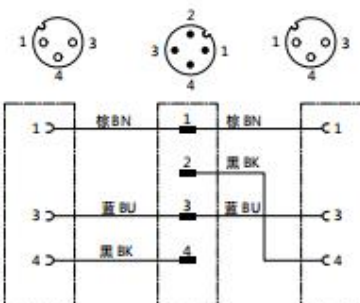

PVC	黑色3m	Y-M12-M04T/2F03T-3.0PVC/BK
PVC	黑色5m	Y-M12-M04T/2F03T-5.0PVC/BK
PVC	黑色10m	Y-M12-M04T/2F03T-10.0PVC/BK
PUR	黑色3m	Y-M12-M04T/2F03T-3.0PUR/BK
PUR	黑色5m	Y-M12-M04T/2F03T-5.0PUR/BK
PUR	黑色10m	Y-M12-M04T/2F03T-10.0PUR/BK
拖链	黑色3m	Y-M12-M04T/2F03T-3.0TL/BK



2、常规I/O连接器-M12系列/M12 series

VELLEDO
— 为乐电气 —

M12
系列

3、**法兰产品**：3芯、4芯、5芯、8芯、12芯；公头、母头；前法兰和后法兰；现场焊线和预铸；





2、常规I/O连接器-7/8系列/ 7/8 series

7/8
系列

1、现场接线：4芯、5芯；公头、母头；直头、弯头

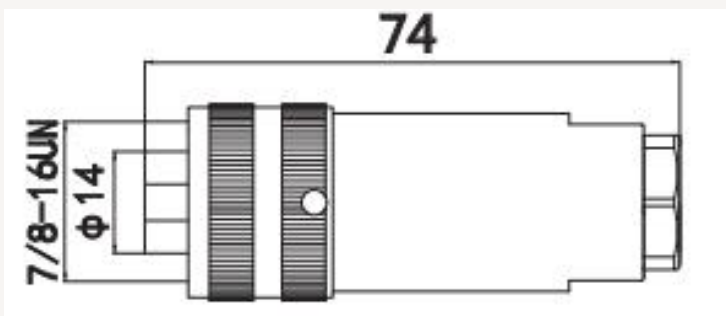

现场接线
Field-wireable
螺钉压接
Screw terminals



ISO 9001 (2015) 质量管理体系

接线图

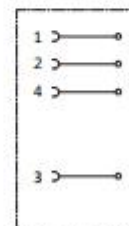
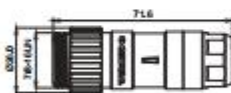

型号 Form

7/8-M04T

7/8-F04T

新品



2、常规I/O连接器-7/8系列/ 7/8 series

VELLEDOQ
— 为乐电气 —

7/8
系列

1、现场接线：4芯、5芯；公头、母头；直头、弯头





2、常规I/O连接器-7/8系列/ 7/8 series

7/8
系列

2、预铸线束：单端预铸、双端预铸4芯、5芯；公头、母头；直头、弯头



3、产品选型 Product selection



M8、M12、7/8现场
安装接头选型
Site selection of M8,
M12 and 7/8
connectors

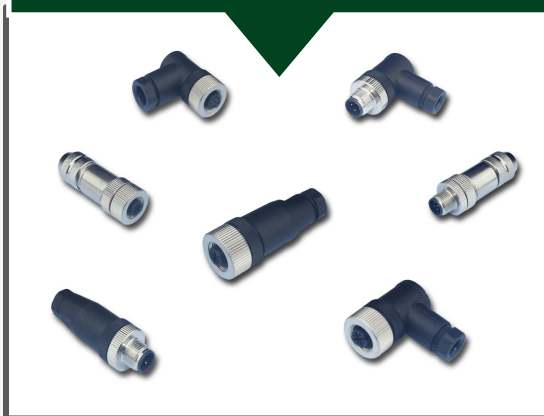

M12 P - M 05 S

系列Series

M8
M12
7/8

屏蔽Shield

P=带屏蔽

类型Type

M=公头
F=母头

芯数Pin

M8:3/4
M12:3/4/5/8/12

形状Shape

T:直头, 180度
S:弯头, 90度

3、产品选型 Product selection



M8、M12、7/8等定制预铸线产品选型
M8, M12, 7/8 and other customized precast line product selection

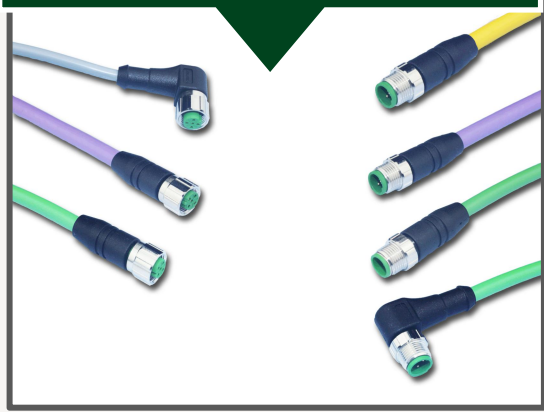

M12 P - M 05 T/F05S- 3.0 PVC/GY

系列Series		线缆材质 Cable material
M8 M12 7/8		PVC PUR TL
屏蔽Shield		线缆长度 Cable length
P=带屏蔽		2.0=2米 3.0=3米
类型Type		线缆颜色 Cable color
M=公头 F=母头		GY: 灰色 BK: 黑色 YE: 黄色 OG: 橙色
芯数Pin	M8:3/4 M12:3/4/5/8/12	形状Shape
		T:直头, 180度 S:弯头, 90度

二、总线连接器 I/O BUS Connector & Harness

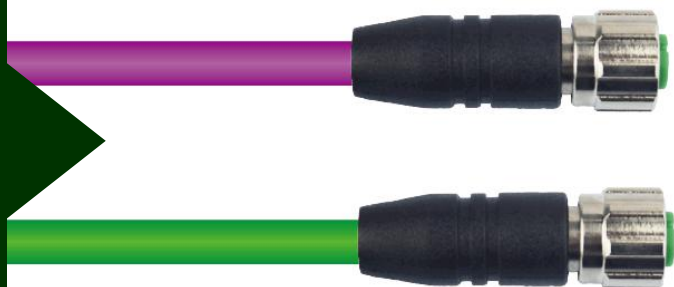

Bus connector harness

适用协议：

PROFI BUS、PROFI NET、
Device Net、Ether CAT、
CANopen、CC-Link、
ASI等总线协议及模块使用





1、ProfiNet协议

1)连接器: RJ45A4、RJ45B4、RJ45C4; RJ45G4



连接附件		型号
	总线RJ45插头180° RJ45 4芯公头	PROFI NET [®] RJ45A4
	总线RJ45插头180° RJ45 8芯公头	EtherCAT [™] EtherNet/IP [®] RJ45AB
	总线RJ45插头90° RJ45 4芯公头	PROFI NET [®] RJ45B4
	总线RJ45插头90° RJ45 8芯公头	EtherCAT [™] EtherNet/IP [®] RJ45B8
	总线RJ45插头180° RJ45 4芯公头	CAT.5e PROFI NET [®] RJ45C4
	总线RJ45插头180° RJ45 8芯公头	CAT.6 EtherNet/IP [®] EtherCAT [™] RJ45CB
	总线RJ45插头180° 广联RJ45套件	EtherNet/IP [®] EtherCAT [™] RJ45D



1、ProfiNet协议

2)连接器: M12 4芯D类4芯现场接线公头、母头; 直头、弯头

VELLE Electric (ShangHai) Co., Ltd.



- 工业以太网
- 工业以太网
- 工业以太网
- 工业以太网
- 工业以太网
- 工业以太网
- 工业以太网
- 工业以太网
- 工业以太网
- 工业以太网

现场接线
Field-wireable
螺钉压接
Screw terminals

屏蔽
Shield
D-CODING



ISO 9001 (2015) 质量管理体系



接线图

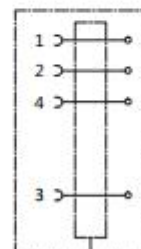
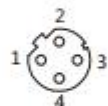
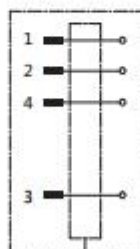
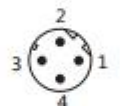
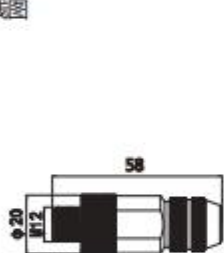

型号 Form

M12P-DM04T

M12P-DF04T

常备品



1、ProfiNet协议

VELLE Electric (ShangHai) Co., Ltd.

3)连接器：RJ45预铸线束



双端预铸线束
Connection cable

屏蔽
Shield

PROFI
NET

CE RoHS

ISO 9001 (2015) 质量管理体系

接线图

固定安装	绿色3m	2RJ45G4- 3.0PNGD/GN
固定安装	绿色5m	2RJ45G4- 5.0PNGD/GN
固定安装	绿色10m	2RJ45G4- 10.0PNGD/GN
移动安装	绿色3m	2RJ45G4- 3.0PNYD/GN
移动安装	绿色5m	2RJ45G4- 5.0PNYD/GN
移动安装	绿色10m	2RJ45G4- 10.0PNYD/GN
插拔	绿色3m	2RJ45G4- 3.0PNFL/GN



1、ProfiNet协议

4)线束及应用:



2*2*22AWG 绿色
屏蔽 固定安装PVC

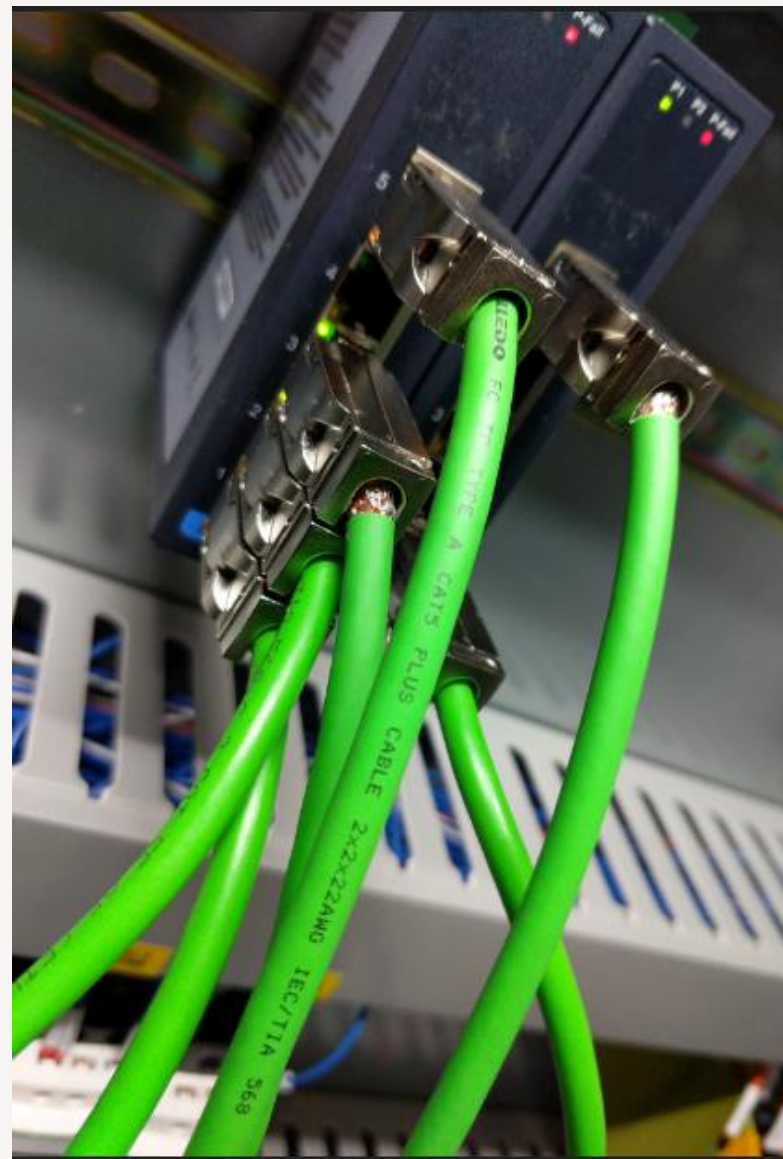



2、ProfiBus协议

1)连接器: M12
B类5芯现场接线

- 物料号
- 物料描述
- 工业以太网
- 总线终端
- 100M以太网
- M12连接器
- M12连接器
- 7芯连接器
- D-Sub

现场接线
Field-wireable
螺钉压接
Screw terminals

屏蔽
Shield
B-CODING



ISO 9001 (2015) 质量管理体系

接线图

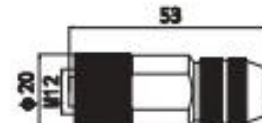
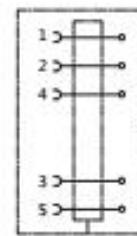
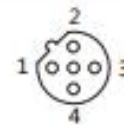
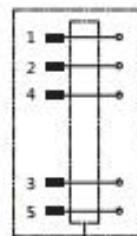
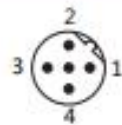
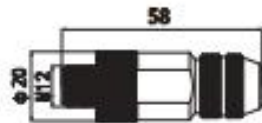

型号 Form

M12P-BM05T

M12P-BF05T

高品质



2、Profibus协议

2)连接器: M12 B类5芯

预铸线束

VELLE Electric (ShangHai) Co., Ltd.



- 双端预铸线束
- 单端预铸线束
- 工业以太网
- 总线终端器
- 100M以太网
- M12预铸线束
- M12预铸线束
- 7芯预铸线束
- 0-5米
- 定制

双端预铸线束 Connection cable

屏蔽
Shield



B-CODING



ISO 9001 (2015) 质量管理体系

接线图

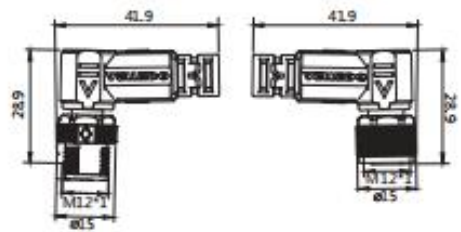
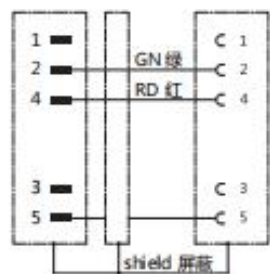
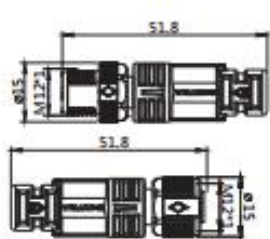
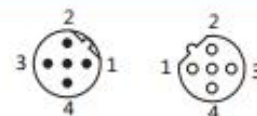

固定安装	紫色3m	M12P-BM05T/F05T-3.0PBGD/VT	M12P-BM05S/F05S-3.0PBGD/VT
固定安装	紫色5m	M12P-BM05T/F05T-5.0PBGD/VT	M12P-BM05S/F05S-5.0PBGD/VT
固定安装	紫色10m	M12P-BM05T/F05T-10.0PBGD/VT	M12P-BM05S/F05S-10.0PBGD/VT
移动安装	紫色3m	M12P-BM05T/F05T-3.0PBYD/VT	M12P-BM05S/F05S-3.0PBYD/VT
移动安装	紫色5m	M12P-BM05T/F05T-5.0PBYD/VT	M12P-BM05S/F05S-5.0PBYD/VT
移动安装	紫色10m	M12P-BM05T/F05T-10.0PBYD/VT	M12P-BM05S/F05S-10.0PBYD/VT
拖链	紫色3m	M12P-BM05T/F05T-3.0PBT/VT	M12P-BM05S/F05S-3.0PBT/VT



2、ProfiBus协议

3)线束及应用:

	<p>1*2*0.64mm² 紫色 屏蔽 适用于拖链</p>	
---	---	---

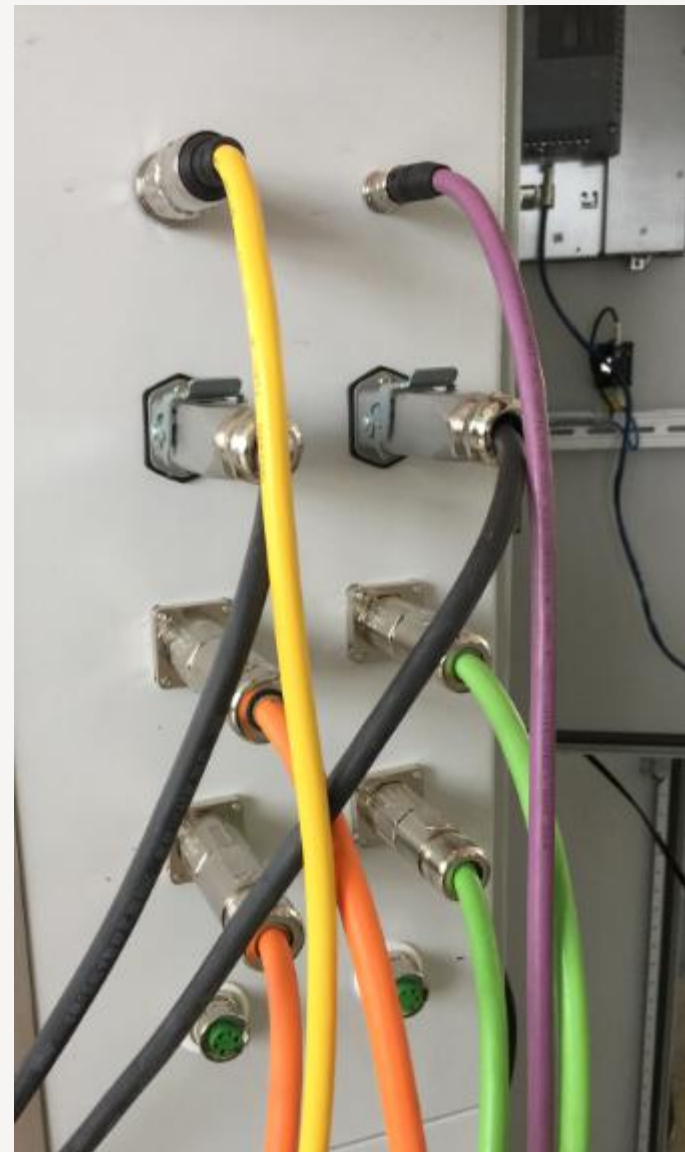



3、DeviceNet协议

1)连接器:

M12 A类5芯线束

(细线)

双端预铸线束
Connection cable



ISO 9001 (2015) 质量管理体系

接线图

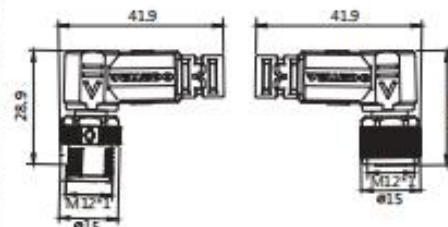
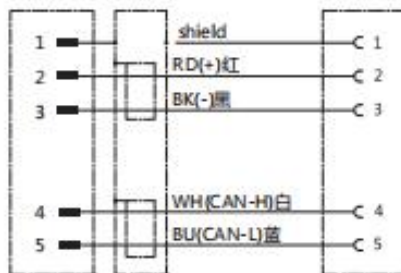
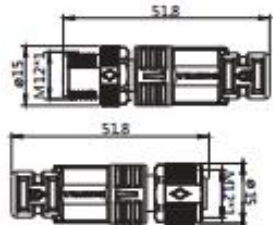

固定安装	黑色3m	M12P-M05T/F05T-3.0DNGD/BK	M12P-M05S/F05S-3.0DNGD/BK
固定安装	黑色5m	M12P-M05T/F05T-5.0DNGD/BK	M12P-M05S/F05S-5.0DNGD/BK
固定安装	黑色10m	M12P-M05T/F05T-10.0DNGD/BK	M12P-M05S/F05S-10.0DNGD/BK
移动安装	黑色3m	M12P-M05T/F05T-3.0DNYD/BK	M12P-M05S/F05S-3.0DNYD/BK
移动安装	黑色5m	M12P-M05T/F05T-5.0DNYD/BK	M12P-M05S/F05S-5.0DNYD/BK
移动安装	黑色10m	M12P-M05T/F05T-10.0DNYD/BK	M12P-M05S/F05S-10.0DNYD/BK



3、DeviceNet协议

2)连接器:

7/8 5芯预铸线束

双端预铸线束
Connection cable



ISO 9001 (2015) 质量管理体系

接线图

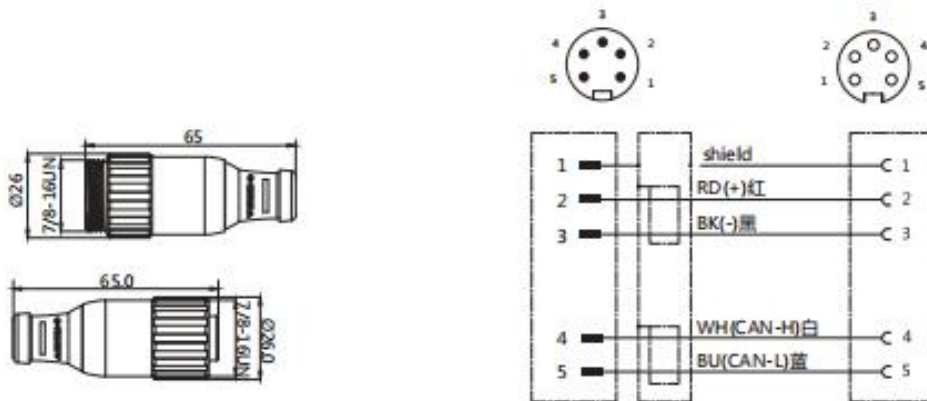

固定安装	灰色3m	7/8P-M05T/F05T-3.0DNNGD/GY
固定安装	灰色5m	7/8P-M05T/F05T-5.0DNNGD/GY
固定安装	灰色10m	7/8P-M05T/F05T-10.0DNNGD/GY
移动安装	灰色3m	7/8P-M05T/F05T-3.0DNYD/GY
移动安装	灰色5m	7/8P-M05T/F05T-5.0DNYD/GY
移动安装	灰色10m	7/8P-M05T/F05T-10.0DNYD/GY

备件号

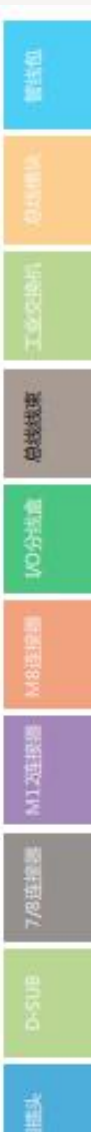



3、DeviceNet协议

3)线束及应用:





	2*0.25+2*0.34mm ² 黑色 屏蔽 适用于拖链	
	2*15AWG+2*18AWG 紫色 屏蔽 适用于拖链	





4、EtherNet/IP协议

2) 线束及应用:

	4*2*26AWG 绿色 屏蔽 适用于拖链	 CAT.5e
	4*2*26AWG 深蓝色 屏蔽 适用于拖链	 CAT.6



三、集线器 (分线盒) Junction Box

匹配插头

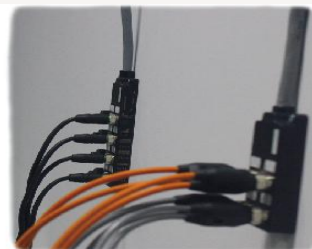

Distribution Systems

多口分配, 让您的现场布线更简洁、方便。





1、M8集线器运用/ M8 junction box

- 1)根据信号极数: M8 4口、8口、12口
- 2)根据接线方式: M8 带插座和带预铸线





2、M12集线器运用/ M12 junction box

1)根据信号极数: M12 4口、8口、12口 2)根据接线方式: M12 带插座、带预铸线、现场接线



4、产品选型 Product selection



M8、M12集线器系列
产品选型
M8 & M12 Junciton
box product
selection



M12 - 8 K 5 P - 3.0 PVC / GY

系列Series

M8
M12

插孔数holes

4、8、12

单位Unit

K即插座口

芯数Pin

3芯、4芯、5芯

信号收发

Signal receiving and sending

P=PNP N=NPN

线缆材质
Cable material

PVC
PUR
TL

线缆长度
Cable length

2.0=2米
3.0=3米

线缆颜色
Cable color

GY: 灰色
BK: 黑色

四、重载连接器 Heavy-duty connector



Heavy Duty connector

完美实现：
气、电、信号、流体
一体化连接





重载连接器 Heavy-duty connector





1、重载连接方式 / Connection mode

开孔安装

Open hole installation

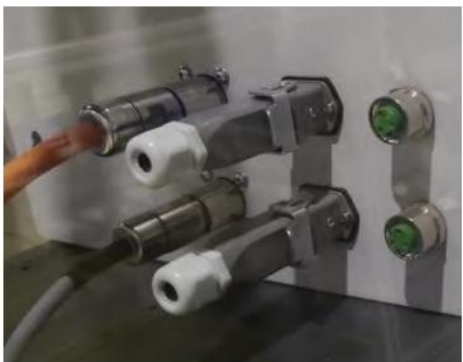

电缆对接

Cable connection



表面安装

surface install



2、重载导线压接类型 /Crimping type

螺钉压接形式
Screw terminal

HA series
HE series
HSB series
HK series
HEAV series

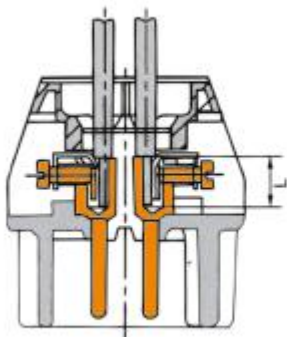

冷压针压接形式
Crimp terminal

HD series
HDD series
HM series (10A)

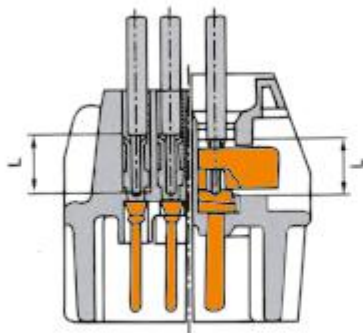

弹片压接端子
Cage-clamp terminal

HES series
HEAVS series

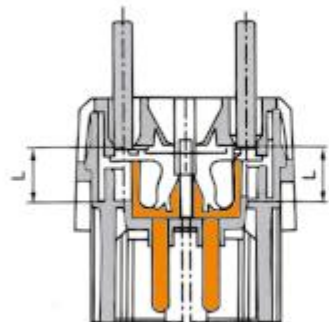

接插芯 Inserts	最大线规 max.wire gauge		剥线长度 Stripping length L (mm ³)
	(mm ²)	AWG	
HA-003, HA-004	2.5	14	4.5
HE, HA, HEAV	2.5	14	7.5
HE	4.0	12	7.5
HSB	6.0	10	11.5
HK	16.0	5	14.0

接插芯 Inserts	线规 Wire gauge		剥线长度 Stripping length L (mm ³)	
	(mm ²)	AWG	HDD / HD	HEC/HAC
HD HDD HM(10A)	0.5	20	8.0	7.5
	0.75	18	8.0	7.5
	1.0	18	8.0	7.5
	1.5	16	8.0	7.5
	2.5	14	8.0	7.5
	4.0	12	—	7.5

接插芯 Inserts	最大线规 max.wire gauge		剥线长度 Stripping length L (mm ³)
	(mm ²)	AWG	
HES, HEAVS	0.14 - 2.5	26 - 14	9...11



3、重载选型指南/Selection Guide



1. 电缆接头/Cable gland

尼龙或铜合金镀镍/Nylon or brass nickel plated
通用电缆接头/Universal cable glands
平口电缆接头(带单层密封圈或多层密封圈)
Cable gland with normal or multiple seal
其它电缆接头/Other cable gland

2. 上壳/Hoods

标准或高结构/Low or high construction
顶部进线或侧面进线/Top or side cable entry
2耳, 4耳或2扣/2blots or 4blots or 2 locking levers

3. 公插体、母插体/Male insert or Female insert

螺丝连接/Screw terminal
冷压连接/Crimp terminal
弹片连接/Cage-clamp terminal



3、重载选型指南 / Selection Guide



3. 公插体、母插体/Male insert or Female insert

螺丝连接/Screw terminal

冷压连接/Crimp terminal

弹片连接/Cage-clamp terminal

4. 冷压针 (适用于冷压接线的插体)/Crimp contacts

(only for crimp connection insert)

镀金或镀银/Golden plated or silver plated

额定电流/Rated current: 5A, 10A, 16A, 40A

5. 下壳/Housings

开孔安装, 表面安装或电缆对接/Bulkhead

mounting or surface mounting or cable to cable

标准或高结构/Low or high construction

1扣, 2扣或4耳/1 or 2 locking levers or 4bolts

带塑料盖或带金属盖或不带盖/With or without

thermoplastic / metal covers



3、重载选型指南--芯子/Core selection

HE-024-M

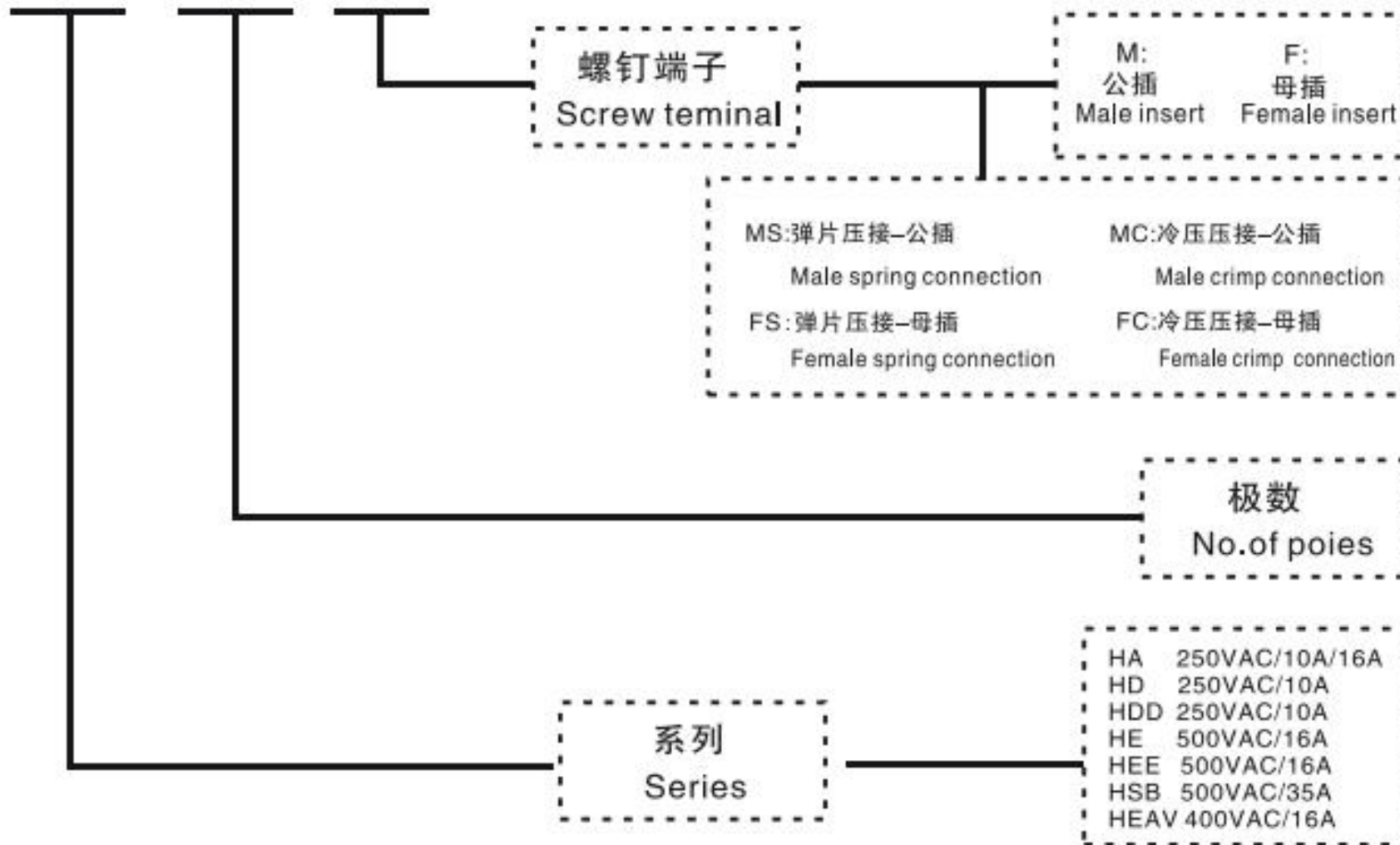



3、重载选型指南--上壳/Top shell selection

H24B- T -4B-PG29

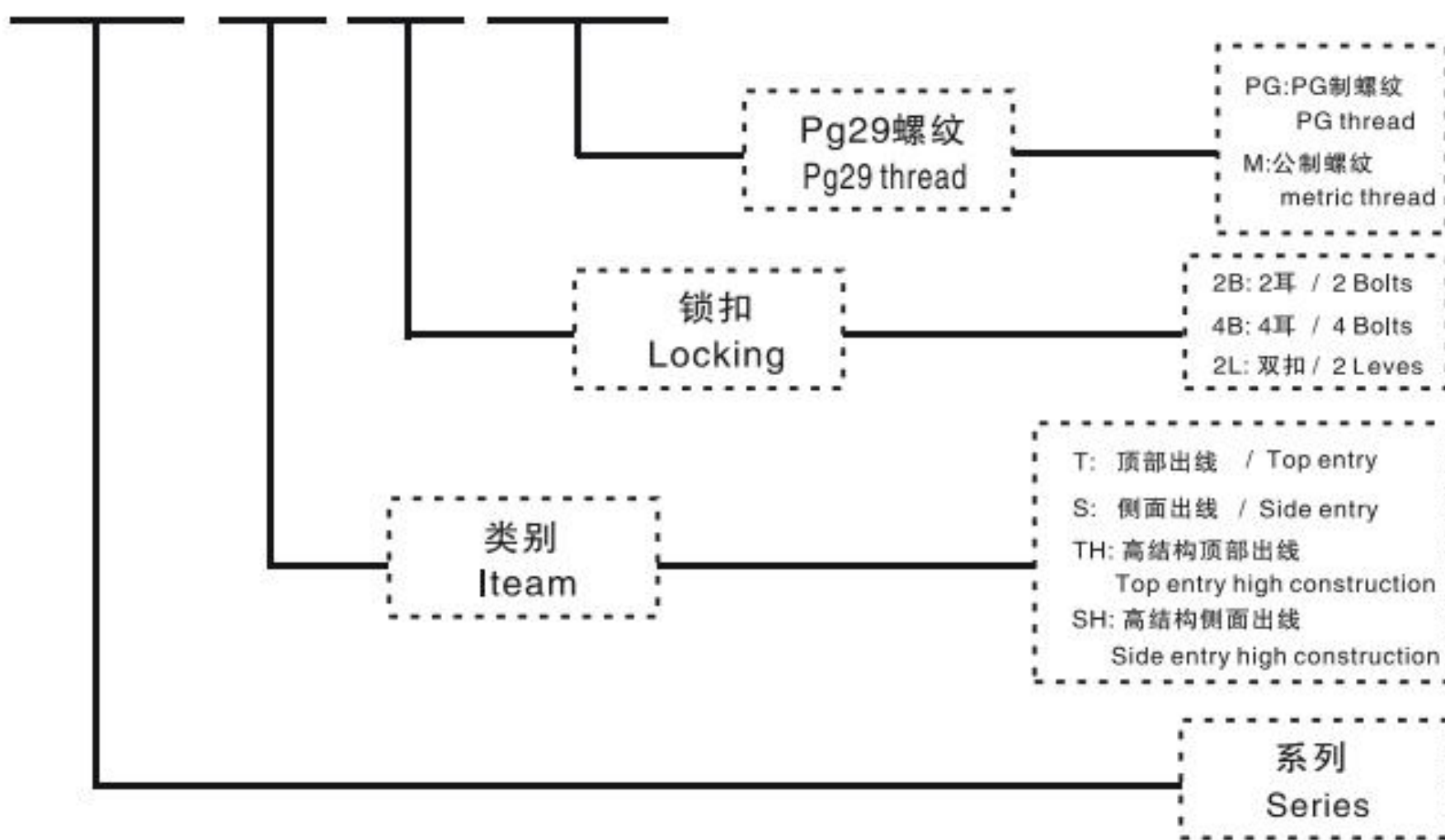

3、重载选型指南--底座/Selection of base

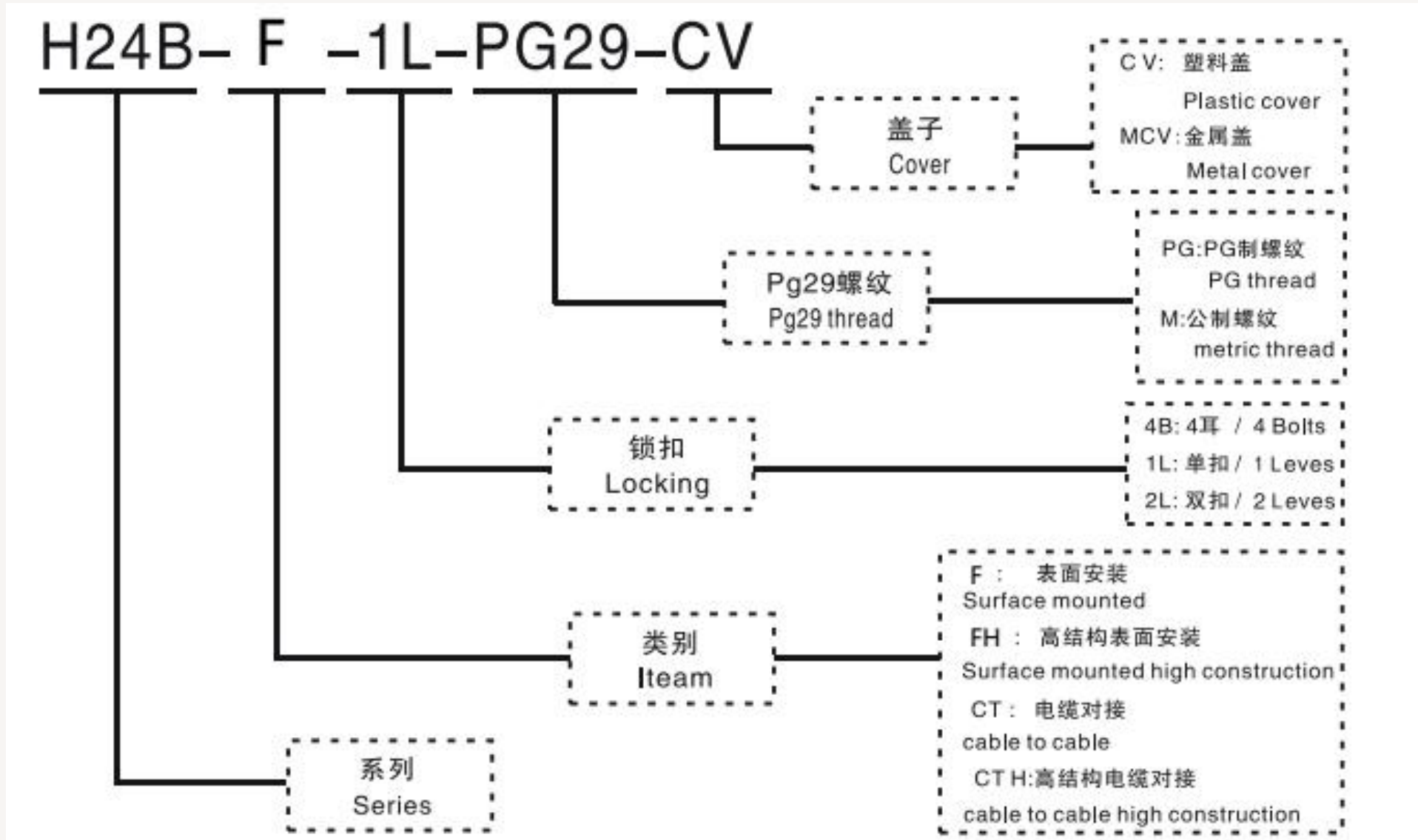

3、重载选型指南--底座/Selection of base

H24B-K-4B-CV

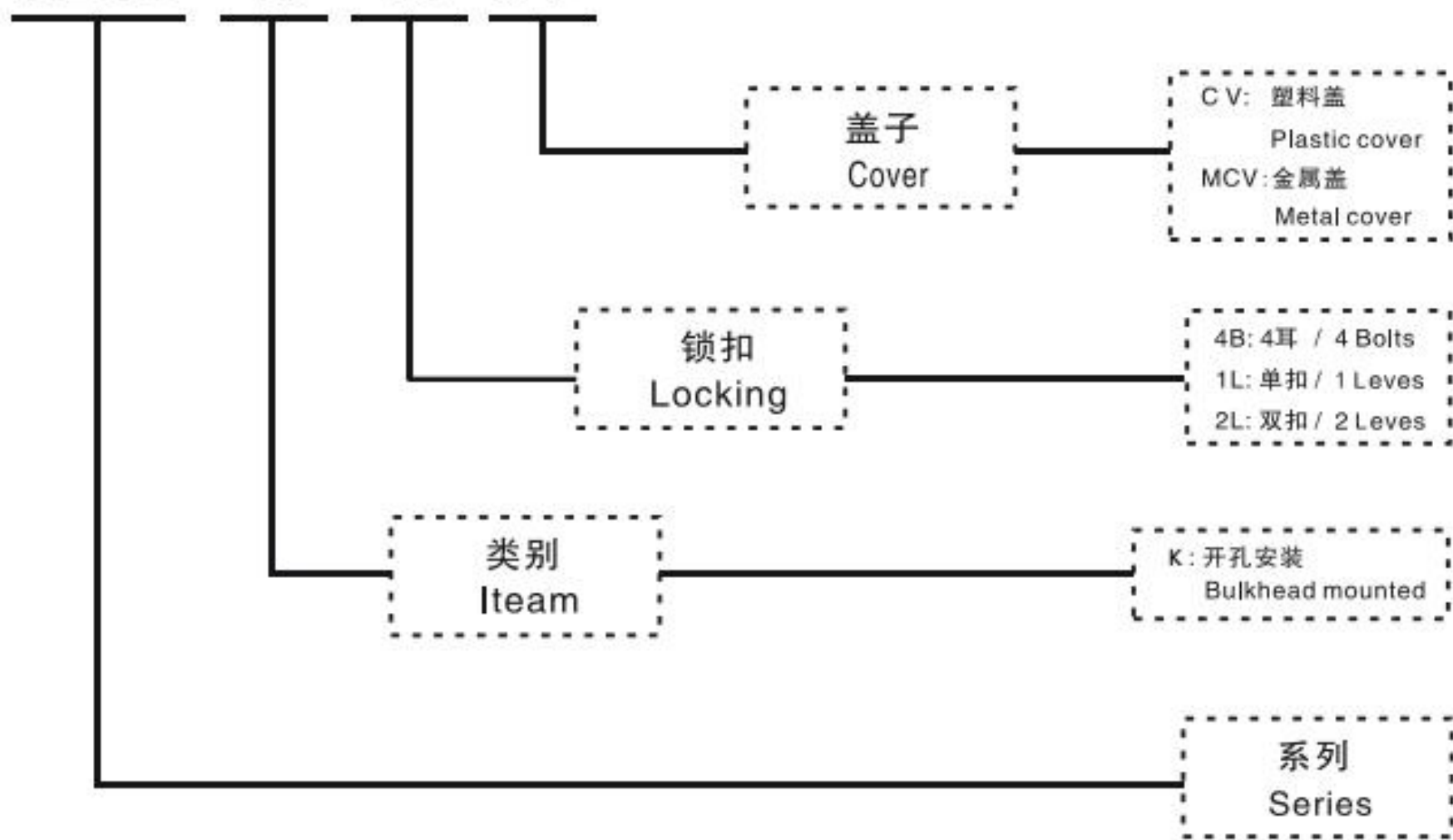



4、重载现场应用方向/Application direction

1) 紧凑型标准连接器：HA系列



2) 最常规标准型连接器：HE系列





4、重载现场应用方向/Application direction

3) 高密度连接器：HEE系列



4) 超高密度连接器：HD、HDD系列





4、重载现场应用方向/Application direction

VELLEDO
— 为乐电气 —

5) 35A大电流连接器：HSB系列



6) 大电流连接器：HK系列





4、重载现场应用方向/Application direction

7)紧凑的小体积连接器：HQ系列



8)模块组合连接器：HM系列



5、重载配套电缆接头/Waterproof joint

分为金属接头、塑料接头、软管接头

VELLE Electric (ShangHai) Co., Ltd.



- 工业级
- 工业级
- 工业级
- 工业级
- 工业级
- 工业级
- 工业级
- 工业级
- 工业级
- 工业级

线缆接头 Cable joint

电缆连接附件/Cable fittings and accessories

金属电缆接头
黄铜镀镍
IP68

Cable glands, IP68, brass nicked-plated

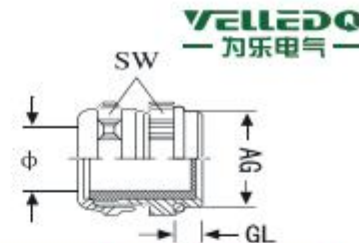

螺纹规格 Thread	卡口范围 Clamping range	螺纹外径 AG	扳手尺寸 SW	螺纹长度 GL	型号 Designation	订货号 Order No.
PG						
Pg7	3-6.5	12.5	14	6	WLA-PG7(3-6.5)	7 000 85 300
Pg9	4-8	15.2	18	6.5	WLA-PG9(4-8)	7 000 85 301
Pg11	5-10	18.6	20	7	WLA-PG11(5-10)	7 000 85 302
Pg13.5	6-12	20.4	22	7.5	WLA-PG13.5(6-12)	7 000 85 303
Pg16	8-14	22.5	25	7	WLA-PG16(8-14)	7 000 85 304
Pg21	13-18	28.3	30	8	WLA-PG21(13-18)	7 000 85 305
Pg29	18-25	37	40	9.5	WLA-PG29(18-25)	7 000 85 306
Pg36	22-32	47	50	12	WLA-PG36(22-32)	7 000 85 307
Pg42	31-38	54	58	12	WLA-PG42(31-38)	7 000 85 308
Pg48	37-44	59.3	65	12	WLA-PG48(37-44)	7 000 85 309
Metric						
M12 × 1.5	3-6.5	12	14	6	WLA-M12(3-6.5)	7 000 85 310
M14 × 1.5	3-6.5	14	15	6	WLA-M14(3-6.5)	7 000 85 311

五、机器人管线包 Robot Dresspack

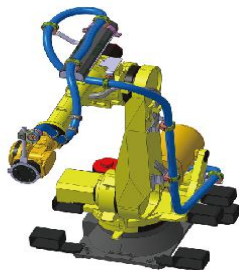

Robot auto technology

可完美匹配：
KUKA机器人
ABB机器人
新松机器人
等各大品牌机器人安装调试



1、机器人管线包配件/Package Accessories

图片 Picture	名称 Name	尺寸 Size	型号 Model
	固定座 System holder	适用于36、48款	WL-D48/36-001
		适用于70款	WL-D70-001
	定位环 Positioning ring	适用于36款	WL-D36-002
		适用于48款	WL-D48-002
		适用于70款	WL-D70-002
	防碰撞环 Anti collision	适用于36款	WL-D36-003
		适用于48款	WL-D48-003
		适用于70款	WL-D70-003
	末端套筒 Terminal Kit	适用于48款	WL-D48-004
		适用于70款	WL-D70-004
	前端套筒 Front end Kit	适用于48款	WL-D48-005
		适用于70款	WL-D70-005

图片 Picture	名称 Name	尺寸 Size	型号 Model
	球型适配器 Ball adapter	适用于36款	WL-D36-006
		适用于48款	WL-D48-006
		适用于70款	WL-D70-006
	活动瓦形件 Movable tile	适用于36款	WL-D36-007
		适用于48款	WL-D48-007
		适用于70款	WL-D70-007
	导向套筒 Guide sleeve	适用于48款	WL-D48-008
		适用于70款	WL-D70-008
	分线器 Splitter	适用于48款	WL-D48-009
		适用于70款	WL-D70-009
	软管 hose	36款软管	WL-R-D36
		48款软管	WL-R-D48
		70款软管	WL-R-D70



1、机器人管线包配件/Package Accessories

图片 Picture	名称 Name	尺寸 Size	型号 Model
	导轨伸缩盒 Guide rail expansion box	适用于70软管	WL-SSH-7001
	弹簧伸缩盒 Spring expansion box	适用于48软管	WL-TH-804
		适用于70软管	WL-TH-806
	U型伸缩盒 U telescopic box	适用于70软管	WL-BOX-70
	6轴支架 Shaft bracket	适用于140法兰盘	WL-WQP-140
		适用于160法兰盘	WL-WQP-160
		适用于200法兰盘	WL-WQP-200
	固定块 Fixed steel block	适用于27支架	WL-GDZ-27
		适用于34支架	WL-GDZ-34



2、机器人管线包配置/Package Configuration

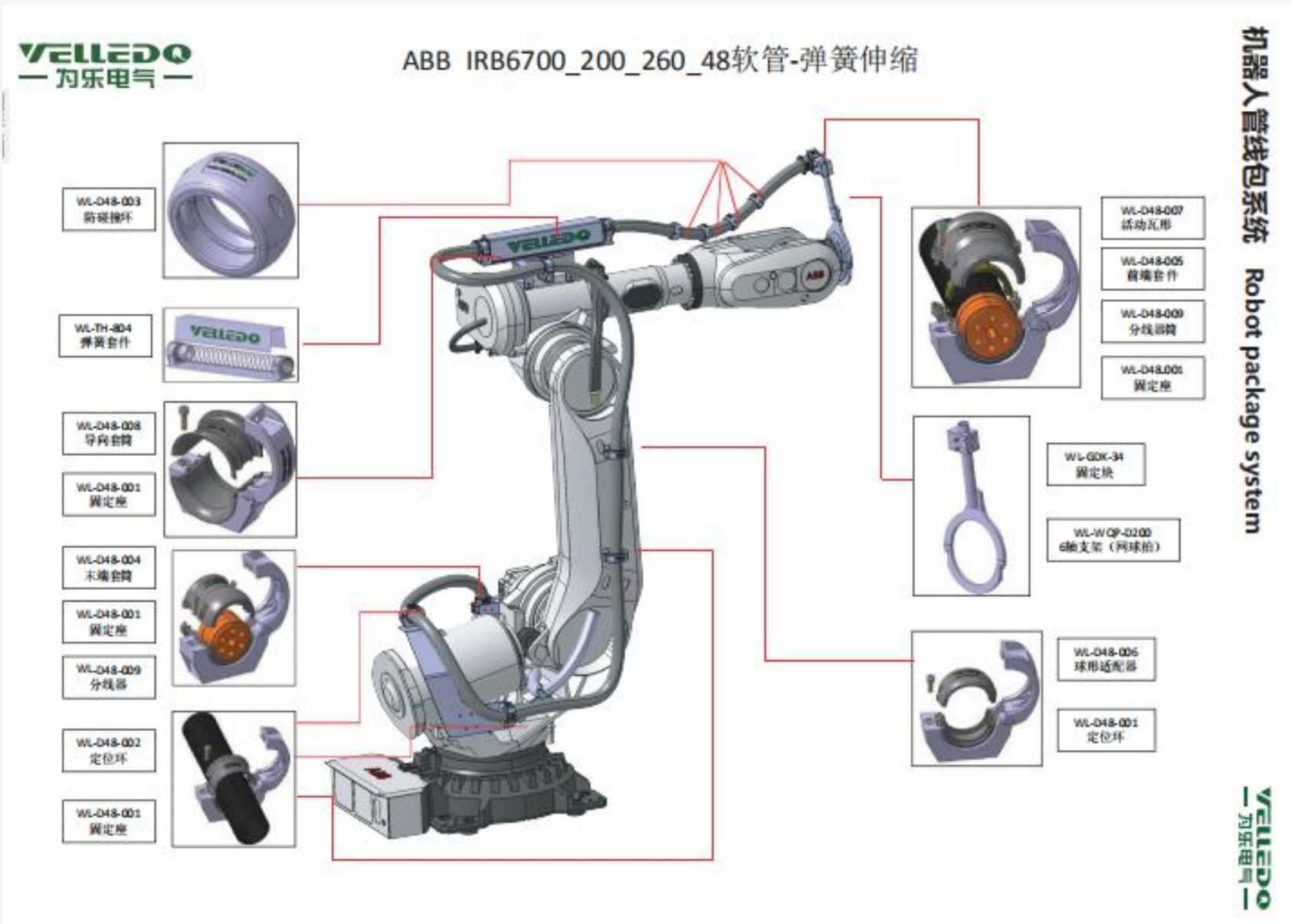



2、机器人管线包配置/Package Configuration

VELLEDO
— 为乐电气 —

VELLE Electric (ShangHai) Co., Ltd.

VELLEDO
— 为乐电气 —

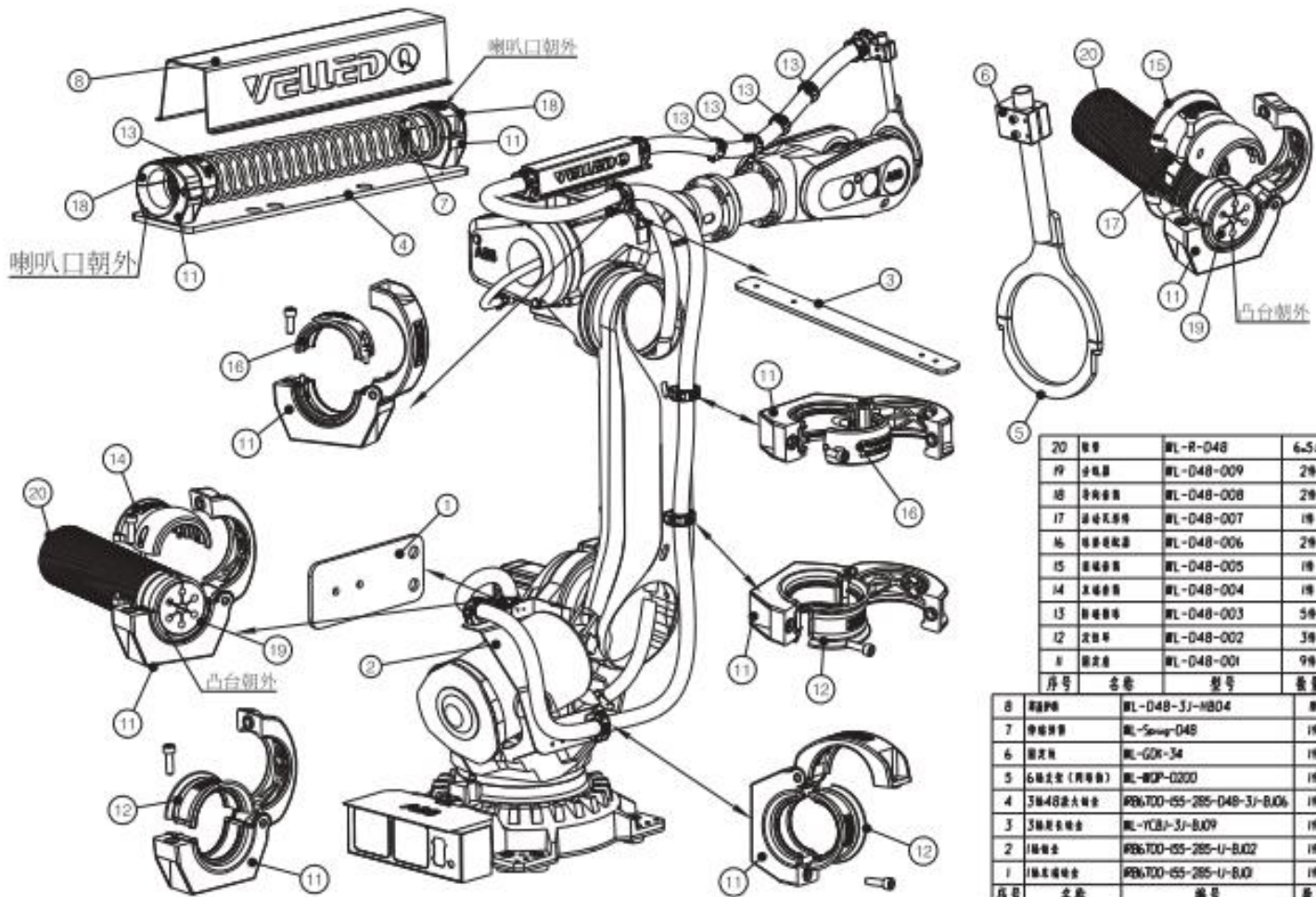

机器人管线包系统 Robot package system

20	螺母	ML-R-D48	6.5#
19	凸块盖	ML-D48-009	2#
18	喇叭盖帽	ML-D48-008	2#
17	喇叭孔零件	ML-D48-007	1#
16	喇叭限位盖	ML-D48-006	2#
15	喇叭盖帽	ML-D48-005	1#
14	耳轴盖帽	ML-D48-004	1#
13	喇叭盖帽	ML-D48-003	5#
12	限位盖	ML-D48-002	3#
11	限位盖	ML-D48-001	9#
序号	名称	型号	数量

8	螺母	ML-D48-SJ-HB04	1#
7	喇叭盖帽	ML-Scrup-D48	1#
6	限位盖	ML-GOK-34	1#
5	6轴底座 (共4轴)	ML-WCP-0200	1#
4	3轴48度大螺母	RB6700-55-285-D48-3J-BJ06	1#
3	3轴螺母	ML-YCBJ-3J-BJ09	1#
2	1轴螺母	RB6700-55-285-U-BJ02	1#
1	1轴底座螺母	RB6700-55-285-U-BJ01	1#
序号	名称	型号	数量

VELLEDO
— 为乐电气 —



4、设计效果3-6轴/Design style

VELLEDO
— 为乐电气 —

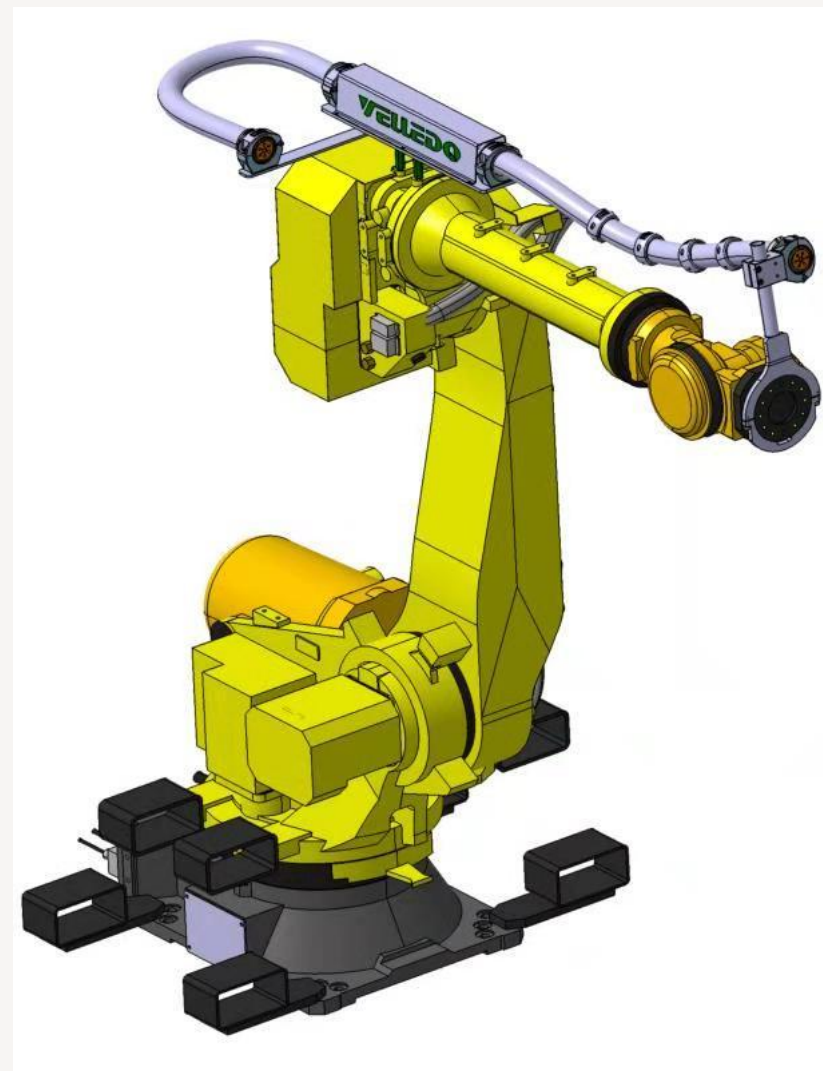
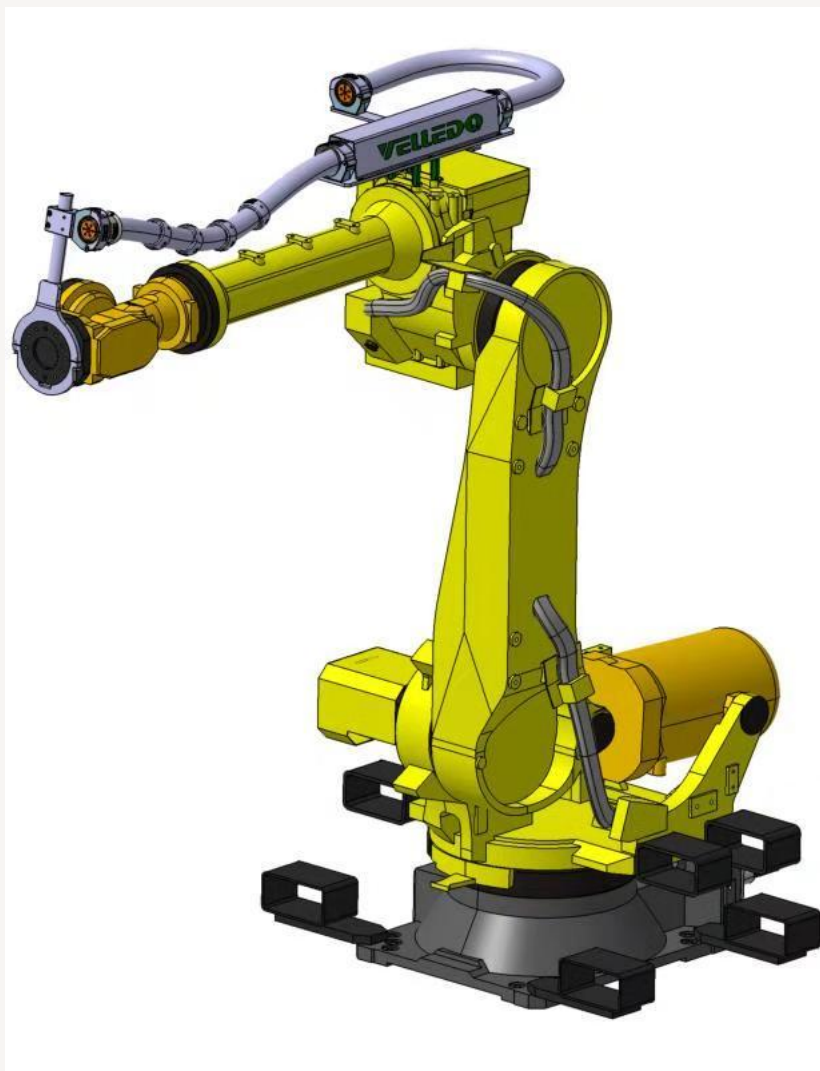



5、设计效果1-6轴/Design style

VELLEDO
— 为乐电气 —

VELLE Electric (ShangHai) Co., Ltd.

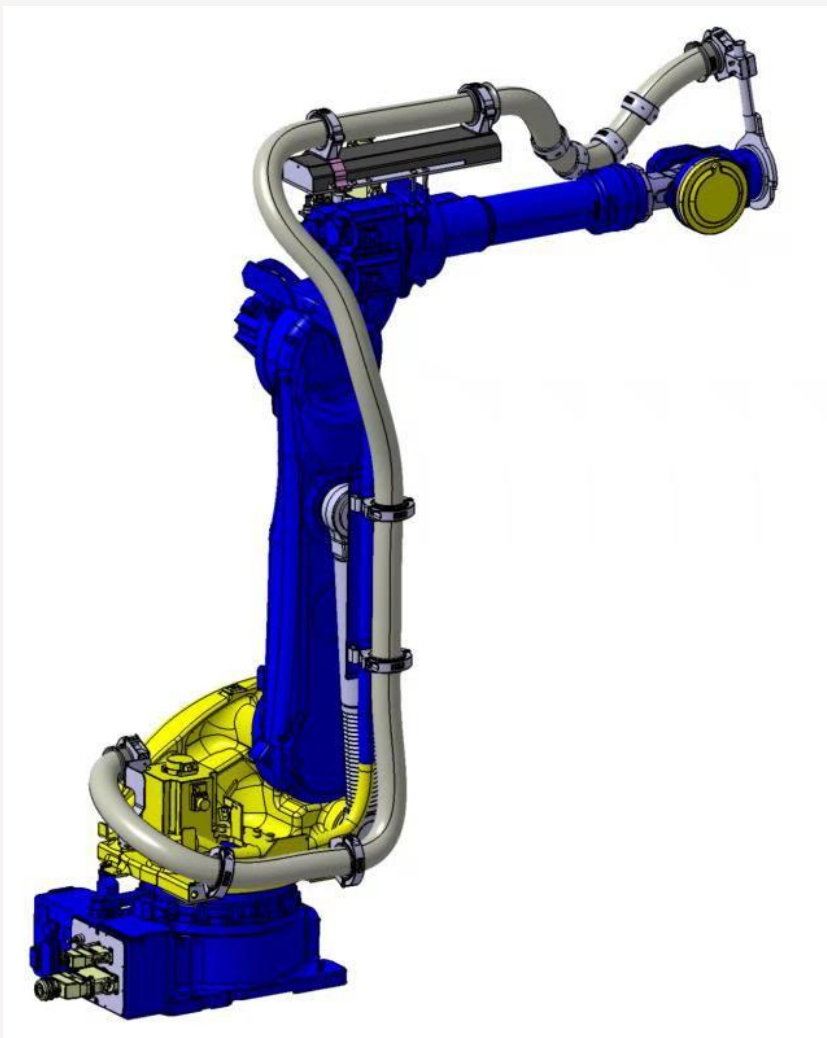



6、设计效果两段式/Design style

VELLEDO
— 为乐电气 —

VELLE Electric (ShangHai) Co., Ltd.

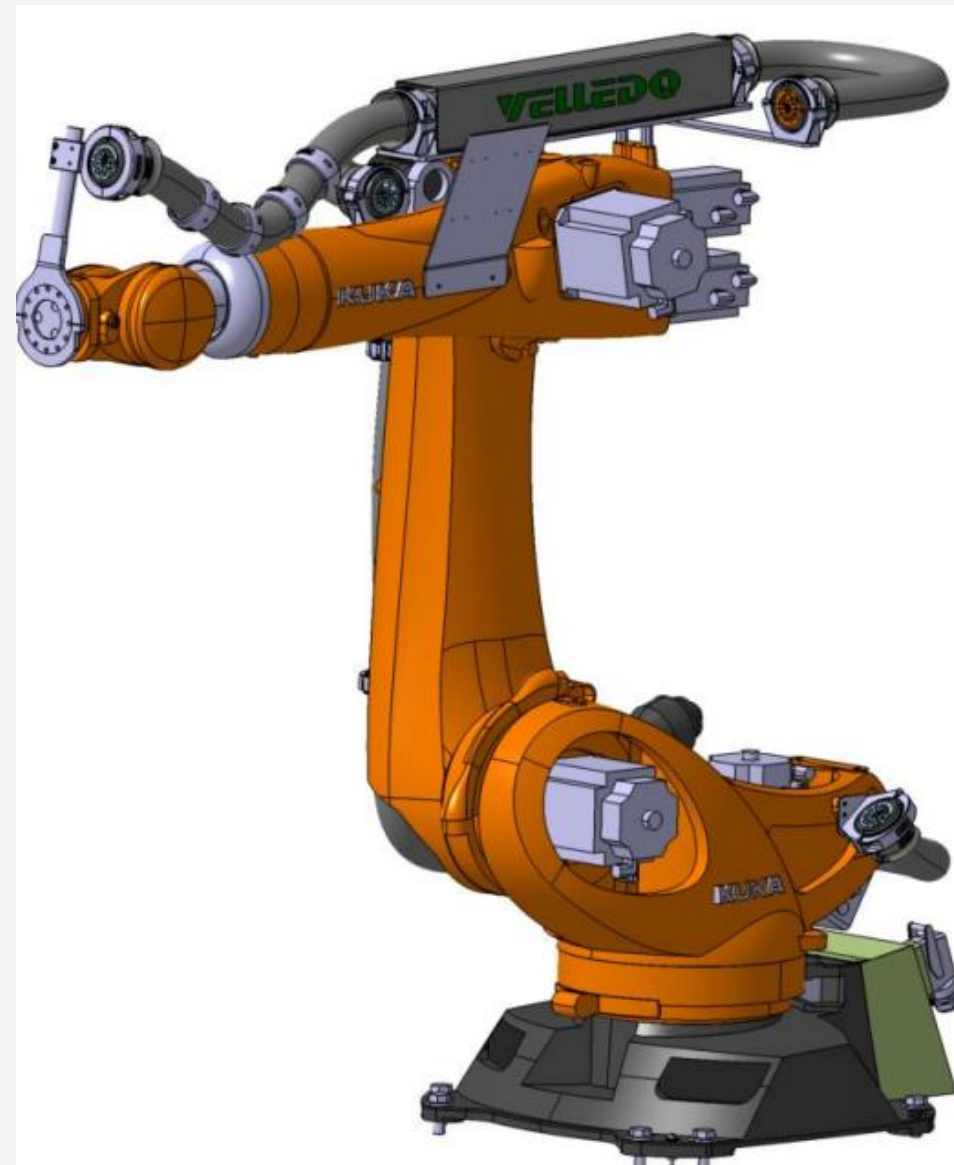



7、设计效果U型枪盘式/Design style

VELLEDO
— 为乐电气 —

VELLE Electric (ShangHai) Co., Ltd.

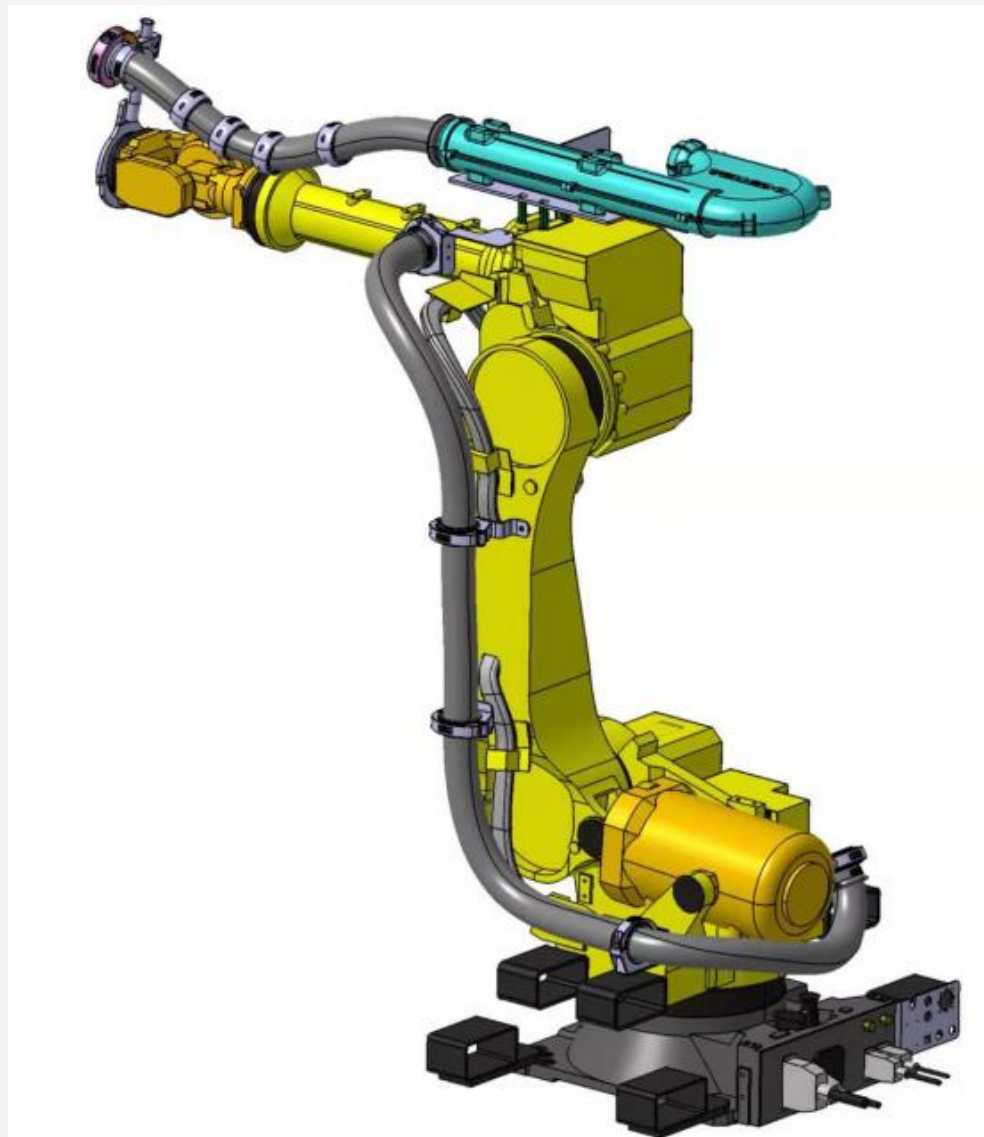



8、设计效果特殊样式/Design style

VELLEDO
— 为乐电气 —

VELLE Electric (ShangHai) Co., Ltd.

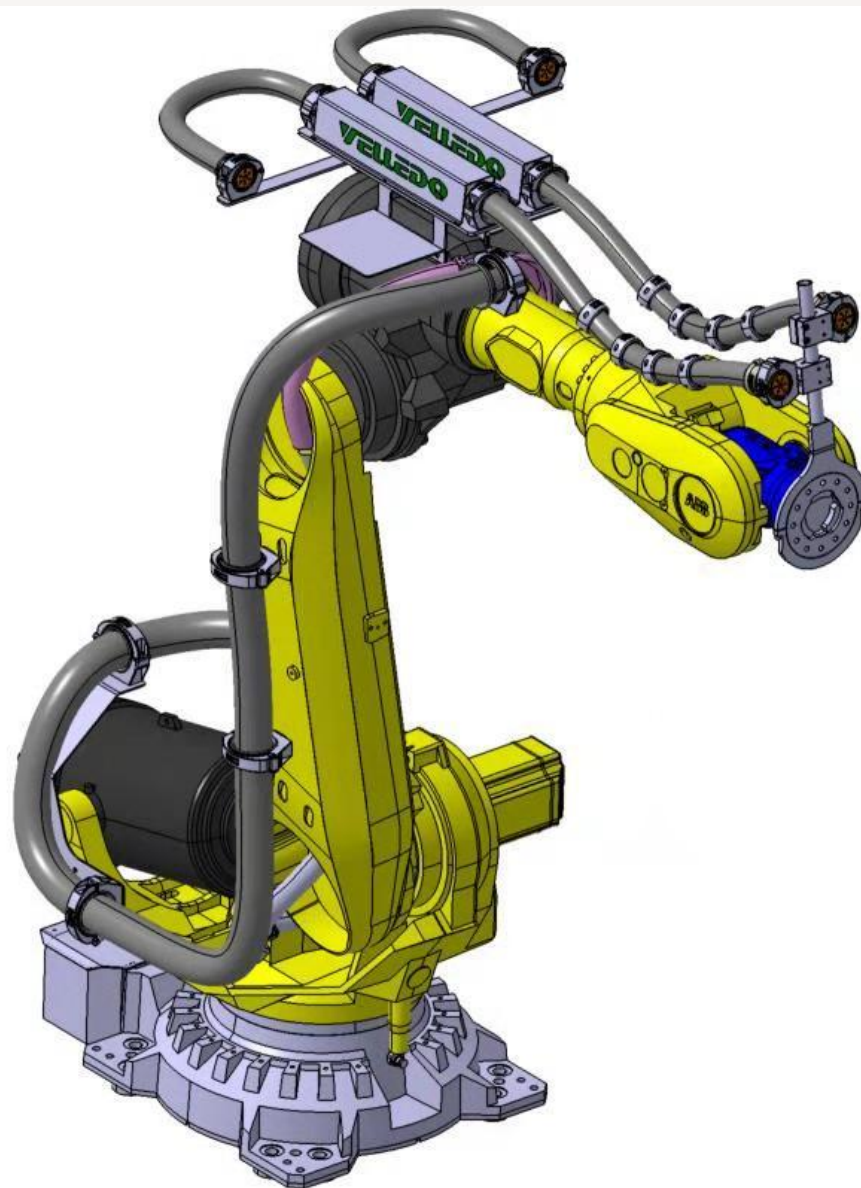
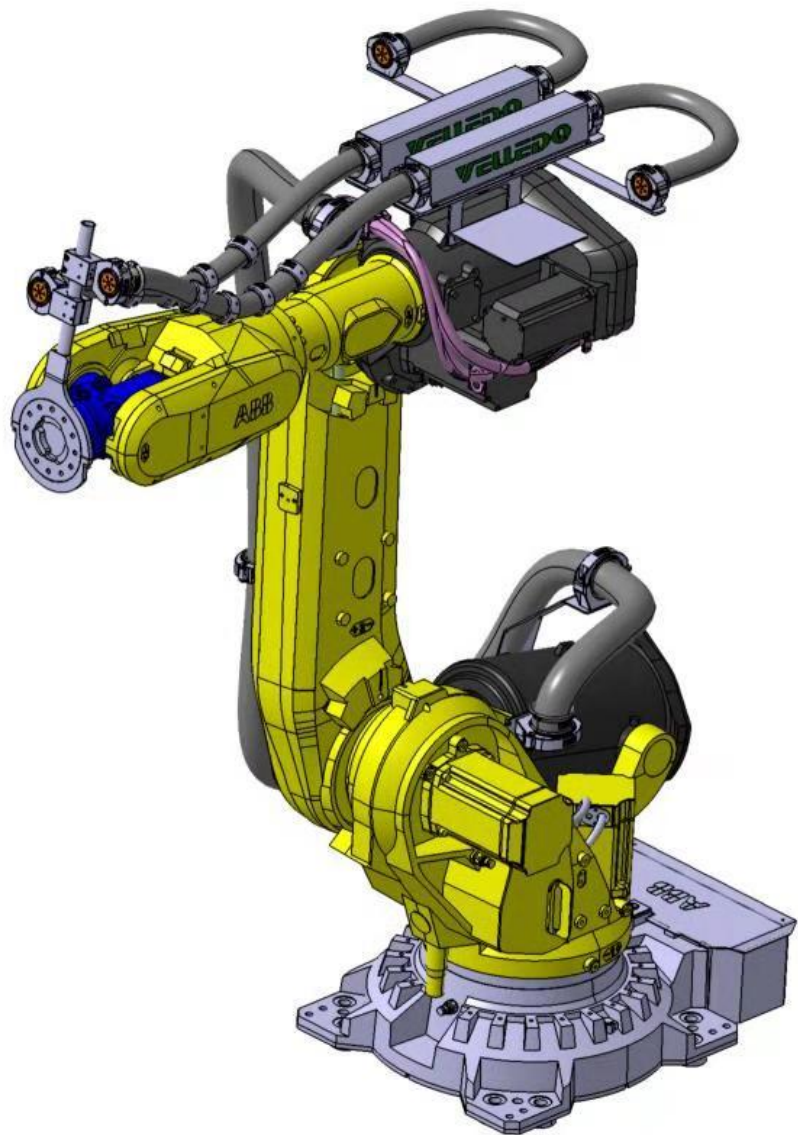

举例

FANUC 2000iC 165F: 伺服点焊机器人管线包配置

S-1

前期与电气和机械工程师沟通，确认机器人技术协议需求（本环节至关重要）

S-2

设计基本管线包方案，出具效果图或CAD数模图

S-3

与需求方确认效果图是否OK

S-4

根据确认后效果图制作BOM表并报价

S-5

确立合同，准备物料并施工（或客户自行安装）

举例

FANUC 2000iC 165F: 伺服点焊机器人管线包配置, STEP-1环节需要确认:

- 1、焊枪线缆: 点焊使用25平方还是35平方线线缆, 一般3条, 2黑1黄绿 (正负极+接地线);
 - 2、伺服线束: FANUC伺服电机使用日标, 分别为动力线4芯; 编码器线10芯; 刹车线3芯;
 - 3、协议线束: 具体需要知道现场使用什么协议? PROFINET、CC-LINK还是PROFIBUS?
 - 4、水管: 一般使用1/2水管, 分为红色 (热水)、绿色 (冷水);
 - 5、信号反馈线束: 根据传感器数量来决定芯数, 一般选择: 20*0.5平特种电缆;
 - 6、气管: 根据工装电气设计要求, 特别注意使用多少路电磁阀? 以及阀导安装的位置在哪里 (常规装3轴和6轴夹具侧)? 来决定使用多大气管? 以及多少根?
 - 7、待上述物料确认后, 还需要确认是1-6轴安装、还是2段式, 或者3-6轴? 当然, 如果阀导装在3轴顶部只能选择2段式或仅3-6轴安装; 同时还需要确认各项管线连接器使用需求。
 - 8、特别需要与客户确认是否还有其他方面的需求? 如是否还有第7轴, 以及是否配置换枪盘等项目, 如有, 则需要有更多的物料需要确认。
- 请就以上内容向客户逐一核实确认, 以避免交通上成本或选型错误。



10、机器人管线包安装案例/Application case

VELLEDO
— 为乐电气 —

VELLE Electric (ShangHai) Co., Ltd.





10、机器人管线包安装案例/Application case

VELLEDO
— 为乐电气 —

VELLE Electric (ShangHai) Co., Ltd.





11、机器人管线包安装案例（A1轴处理）

VELLE Electric (ShangHai) Co., Ltd.





11、机器人管线包安装案例（预安装）



六、总线及线束定制

I/O Bus and Harness Customization



Sensor plug wire harness and flange

M8、M12、7/8等多款法兰
安装连接器及线束
可实现多款柜体出线连接



一、总线模块/ I/O bus module



I/O总线模块

- 清晰的状态指示灯LED
- 功能强大且使用可靠的输出端口
- 综合性能优良PC外壳
- 高密度输入
- 创新的外壳设计





一、总线模块/ I/O bus module

- 0-5111
- 7/8888
- M12连接器
- M8连接器
- M12连接器
- 总线接口
- 工业以太网
- 控制接口
- 设备接口

Profi Net协议



ISO 9001 (2015) 质量管理体系

现场总线端口

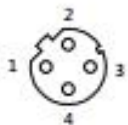

AUX电源端口

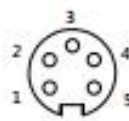

I/O端口

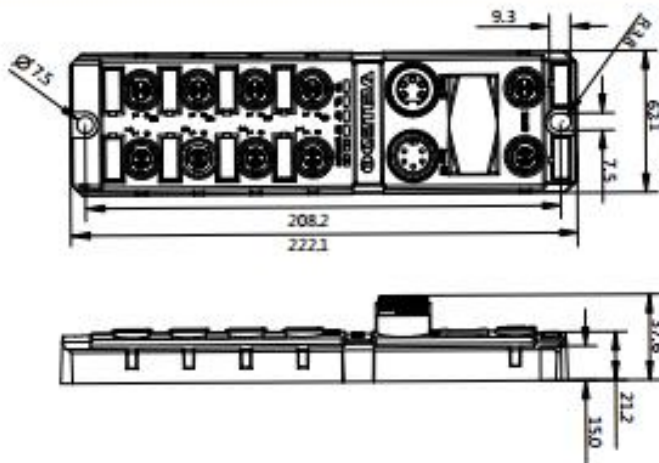
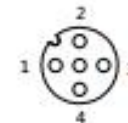

型号 Form :	IO-M12-8K5P-PN-16DI/DO-VER	IO-M12-8K5P-PN-16DI-VER
总线协议	Profi Net	Profi Net



一、总线模块/ I/O bus module





二、交换机/ Industrial switch

VELLEDO
— 为乐电气 —





二、交换机/ Industrial switch

VELLEDOQ
— 为乐电气 —

VELLE Electric (ShangHai) Co., Ltd.

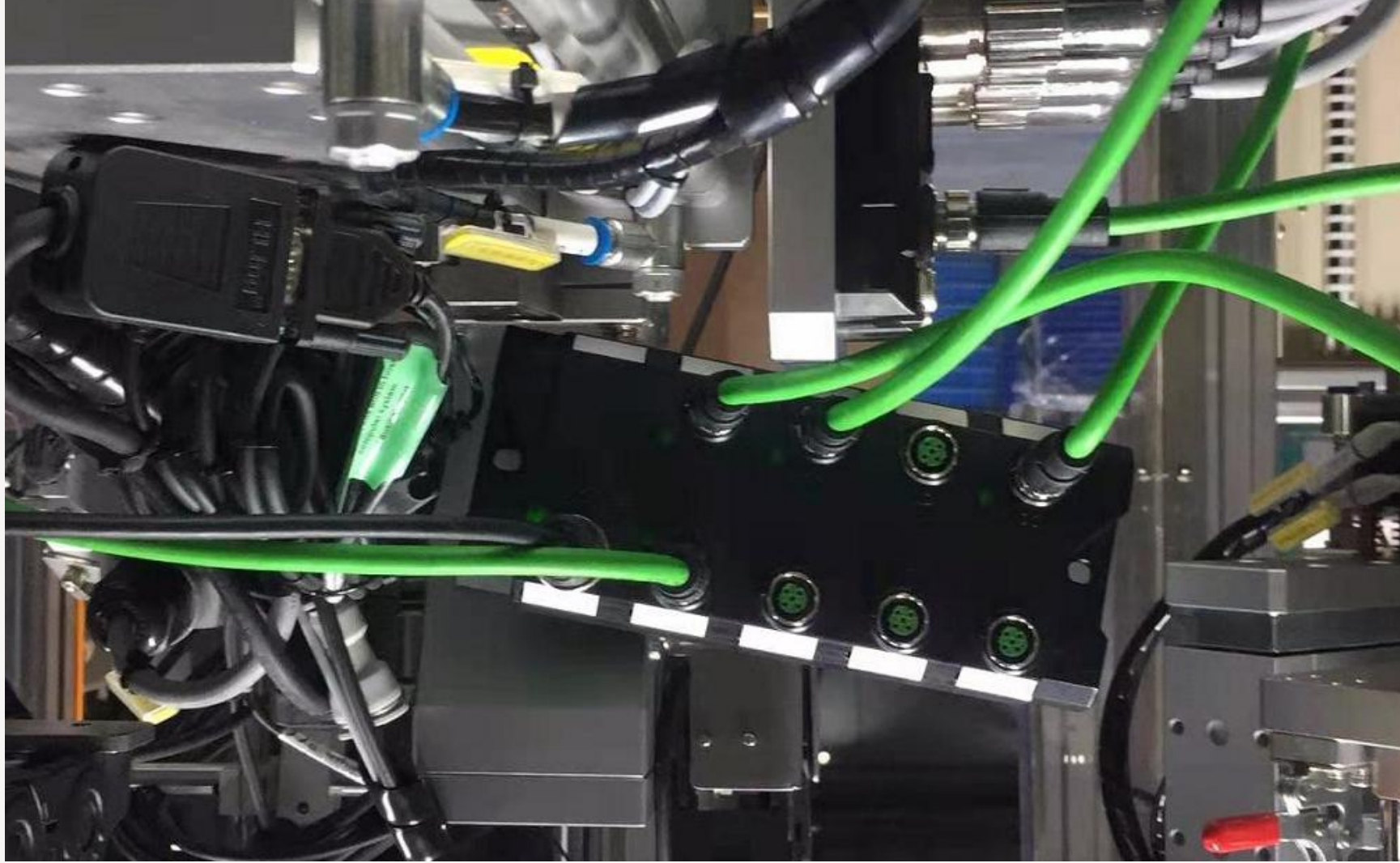



联系我们

Contact us

VELLEDQ
— 为乐电气 —

VELLE Electric (ShangHai) Co., Ltd.



关注我们
Focuses on us



邮箱E~mail: VELLEDQ@VELLEDQ.COM



联系电话Tel: +86-21-62505095



企业官网Website: WWW.VELLEDQ.COM



微信Wechat: 为乐电气, VELLEDDQ



地址: 中国上海市松江区书海路500号1号楼
Add: Building 1, No.500 Shuhai Road Songjiang District, Shanghai, China

感谢您的指导

Thank you for your guidance